

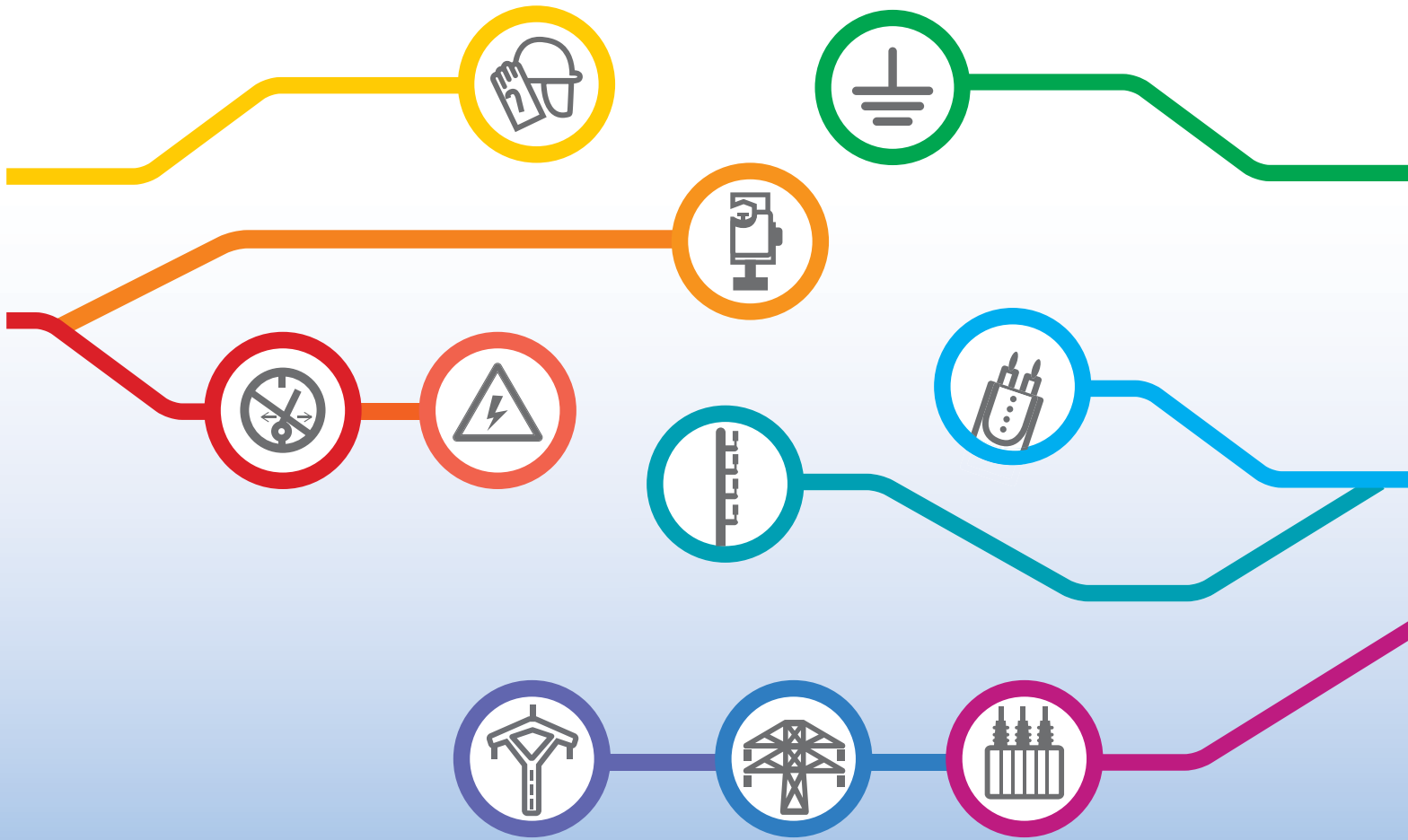

The world of electrical safety

2017/2018





Electrical safety,
our business.

Now more than ever, working safely is essential for all professionals in the electrical industry.

In Europe and in the rest of the world, new clearances allow a larger population of people to perform electrical and non-electrical work on or around installations and structures, in compliance with prevention rules.

This major change, supports better risk analysis and strict adherence to the supervision chain, in order to further improve operator safety.

From this standpoint, CATU is fully committed to supporting you in these changes.

Firstly, with many new products designed and produced by our teams for you.

Next, with a completely redesigned catalogue that focuses on our products, their functions, and their use.

Finally, with new educational tools, including our convenient guides that provide simple and helpful information.

It's time to work with lasting safety, and we are here to help you, the Pros!

Thank you for your confidence in us!



*Electrical safety,
for pros like you!*



IEC













TESTING

ACCREDITATION N°1 - 0897
SCOPE AVAILABLE ON
www.cofrac.fr



ISO 9001 - ILO-OSH 2001
OHSAS 18001 - ISO 14001

Personnal and collective protective equipement	15	
Locking	71	
Signaling	87	
LV test and measurement	93	
LV earthing systems	105	
LV live working tools	111	
MV Substation equipment	149	
Medium voltage equipment	169	
HV lines and swtichgear equipment	185	
Earthing connections	195	

Personal and collective protective equipment.....15

PPE, CPE : key advantages in risk prevention	17
Eyes protection	18
Head protection	20
Insulating rubber gloves.....	23
Insulating boots	28
Safety shoes	29
Insulating mats and accessories	31
Accessories and insulating platforms	33
Arc Flash Protection	31
Arc Flash equipment	36
Other protection	41
Workwear and other protections.....	42
Work at height	44
Equipment for working on pole : harness.....	45
Equipment for working on pole : harness and kits.....	47
Equipment for working on pole : kits	49
Equipment for working on pole : tool bag and anti-fall	52
Equipment for working on pole : anti-fall and tether.....	53
Equipment for working on pole : tether and safety line	55
Equipment for working on pole : ropes and snap hooks	57
Equipment for working on pole : snap hooks and anchoring accessories.....	59
Equipment for working on pole : climbers and accessories.....	61
Cover-up equipment	62
Equipment for working on pole : insulating ladders	62
Equipment for working on pole : insulating ladders and stepladders	65
Equipment for working on pole : ladders and accessories.....	66

Locking.....71

Locking padlocks	73
Multiple lockers	76
Circuit breaker lockers	78
Circuit breaker lockers, Panels and insert.....	79
Padlock stations.....	80
Fluid locking	82
Cabinets	84
Consignment kits	85

Signaling87

Warning signs	88
Signaling and delineators	91

LV test and measurement93

Voltage Detector	94
Phase rotation indicator	100
Installation Controller	102

LV earthing systems.....105

Overhead bare	106
Overhead insulating	108
LV Cabinets.....	109

LV Live working tools111

Insulated tools	113
Jumper clamps, cables and accessories	144
Cable identifier.....	147

General products index

MV Substation equipment149

Substation equipment	151
Voltage detectors and short-circuiting systems for substations with bare conductors.....	152
Voltage detectors	153
Phase comparators	155
Two-pole phase comparator and permanent indicator	156
IEC short-circuiting and earthing systems for MV substations	157
Clamps for MV installations and substations....	159
Short-circuiting and earthing systems.....	160
Static discharge sticks	162
VPIS and VDS systems for M.V. cubicles	163
Additional safety equipment	165
Life saving kits.....	166

Medium voltage equipment .169

IEC voltage detectors	170
Voltage detectors	171
Single phase comparators.....	172
IEC equipment	173
Insulating sticks.....	174
Clamp dispenser heads and accessories	177
Overhead line systems.....	178
Cables	179
Underground systems	181
Sticks accessories	182
Storage and maintenance products.....	183

HV lines and switchgear equipment185

Voltage detectors	186
Insulating sticks	188
Clamps	189
Earthing system APE	190
Insulating sticks earth clamps and cables	191
Cables and accessories.....	192

Earthing connections.....195

Earth rods	196
Connectors and earth tester	197
Earth resistance tester	198

Golden safety rules.....	199
Choose your gloves size	200
Choose your harness size	201
Short-circuiting and earthing system	203
Specification	

Ascension blocker	58	Copper cables.....	179	Hacksaw	124
Anti fallgrip.....	52	Copper/steel earth rods	196	Hand stick	99
Atex harness.....	45	Cranked ring spanner	126	Helmet with built-in face shield	21
ABS helmet	20	Cut resistant gloves	41	HV and EHV clamps manoeuvrable by insulating stick.....	189
AC voltage detector for outdoor/indoor use....	186	Climbers.....	61	Headlamps for hermet	22
Accessories (measurement kit)	198	Circuit breakers lockers.....	78/79	HV live working shoes.....	30
Adhesive tape.....	70	Consignment kits.....	85/86		
Adjustable access points	192				
Ratchet spanners.....	133	Delineators	92	IEC electronic Voltage Detectors with antenna	153
Aluminium cables.....	180/192	Double lanyard	56	IEC electronic Voltage Detectors, "Compact serie" for indoor and outdoor use.....	152
Anti-fall device with automatic release strap	53	Double safety descent device	57	IEC Insulating stick for Voltage Detector	152
Aperture Housing.....	165			IEC short-circuiting and earthing systems (three-phase crossarm networks)	173
"Arc flash" face shield kit	37	Earth clamp	157/191	IEC Voltage detector.....	170
"Arc flash" jacket and protective coverall kits	38	Earth rod	177	Installation on bare conductors	158
"Arc flash" protective kits (25, 40, 55, 65 or 100 cal/cm ²)	40	Earth resistance tester.....	198	Installation on permanent fixed points.....	157
Arc flash protection	35	Earthing system APE.....	198	Insulated Screwdrivers	113/118
		Earthing equipment	108	Insulating blanket.....	69/181
		Earthing equipment for overhead lines systems.....	106	Insulating boots	28
		Electrician coverall	42	Insulating flexible cover	69
Basic body harness	45	End cutting pliers.....	121	Insulating flexible cover with Velcro™ tape.....	69
Bag for insulator cover.....	67	Equipotential Lines	192	Insulating gloves.....	23
Bags for insulating mats	33	Electrical adhesives tap	70	Insulating harness	45
Bent snipe nose plier	115/120	Electrical tools bag	139	Insulating ladders	62
Blanket clamp	70			Insulating mats.....	31
Bipolar voltage absence detector	156	Face shield	19	Insulating overs shoes	28
Backpack with wheels	140	Fall arrester retractable type.....	53	Insulating platform (outdoor model)	34
Bypass housing	146	Fixed length sticks.....	174	Insulating platforms (indoor models)	33
		Fixing tools for warning signs	92	Insulating stepladders.....	64
		Flat nose plier.....	115/120	Insulating sticks for manoeuvring detectors & short-circuiting and earthing systems....	175
Cable cutter.....	114/120	Flexible - type conductor cover	67	Insulating sticks for short circuiting and earthing systems.....	175/188/191
Cable Identifier	147	Fluid locking	82	Insulating sticks for substation use	161
Cable spike equipment	181	Folding stepladder with railing	65	Insulating tool kits	116/135/137
Cable testing stick	181	Forked Lanyard with energy absorber.....	45	Insulating torque wrench 3/8"	133
Carrying bag	27/95/97	Frontal ratchet cable cutter.....	120	Insulation controller	103
Chain delineators.....	92	Full body fall arrest harness.....	47	Insulator cover.....	67
Clamp dispenser heads	177	Fuse puller	182	Integrated voltage detecting system (V.D.S)	163
Clamps for installation on bare conductors	159	Fall arrest basic kit	47	Integrated voltage presence indicating system (V.P.I.S)	163
Cleaning brushes.....	182	Fall protection kit	48/49/50/51	Interface for integrated voltage detecting	
Cold Protection Kit and Cap	43	Fall arrester.....	52/53		
Come-along.....	149				
Come-along.....	149	Grounding and continuity measurement device	102		
Compact carrying KIT	167	Grounding flags	91		
Complete intervention kit.....	116/134	Gloves box.....	26		
Connection adaptors for insulating sticks	176				
Connector.....	197				
Constraint tie.....	60				
Contact probes for L.V. tester	99				

General products index

system (V.D.S)	163
Intervention kit	116/134
Intervention kit for electricians	143
Intervention kits Substation equipment	151
<hr/>	
Jumper cable with insulating jumper clamps	145
Jumper cables realisation specially manufactured items	180
Jumper connecting box with fuse	146
<hr/>	
Kit for restraint at work	47
<hr/>	
Lanyard	56/57
Lead set for checks on L.V distribution board	104
LED's headlamp	22
Life saving kits for M.V. substations	166
Long nose pliers with side cutter	120
Lockers	76/77
Low voltage complete set. Complete equipment for live line (LV) interventions	142
Lowlock system	108
<hr/>	
Manœuvring and rescue stick	165
Manœuvring hook	182
Mechanical climbers for rectangular shaped concrete poles	61
Mini jumper clamps fully insulating for switchboard use	144
Mittens	28
Mobile safety line	56
Multi-pockets electrician bag	33
Multiple Locker	76
<hr/>	
Open jaw spanner	126
Operating Testers	155
Overglasses	18
Overgloves	27
<hr/>	
Padlocks	73
Padlocks stations	80
Padlocks cabinets	84
Permanent luminous indicator for indoor use	156
<hr/>	
Phase rotation indicator	100
Pliers	115/120
Pliers kit	116/134
Plug plier for preinsulating pin terminals	120
Pneumatic glove tester	26
Polycarbonate helmet	20
Pro electric full body fall arrest harness	46
<hr/>	
Ratchet cable cutter	124
Rescue hook	167
Rope operated clamp	193
Round nose plier	115/120
Rod tester	183
<hr/>	
Safety adhesive tape	92
Safety boundary post	91
Safety glasses	18
Safety lamps	165
Safety rope with wear tell tales	57
Safety Shoes	29/42
Scissors	133
Screwdrivers PHILLIPS	113/118/119
Screwdrivers POZIDRIV	113/119
Screwdrivers kit	116/134
Self adhesive warning signs	90
Separable voltage detecting system (V.D.S)	164
Set of sticks	188
Short length stick	135
Short-circuiting and earthing systems carrying bags	192
Short-circuiting device for LV Cabinet	109/110
Short-circuiting systems HV	189
Short-circuiting systems LV	106
Short-circuiting system MV	178
Short-circuiting system MV substation	157
Shunt Telescopic probe	146
Side cutters	115
Single pole phase comparator for indoor and outdoor use	172
Snap hook with double safety latch	59
Snap hook with stick adaptor	60
Snap hooks	58
Socket 3/8"	128/130
Sockets wrenches sets	132
<hr/>	
Sound phase comparator	163
Spool with earthing connection	177
Stainless steel earth rods	196
Standard electronic voltage detector for indoor and outdoor use	171
Standard extension ladders	63
Standard sticks	161
Static discharge stick	162
Sticks with rain skirts	161
Storage bag	104/99
Stripping plier for LV cables	123
Substation signs	89
Socket lockers	81
<hr/>	
Telescopic stick for voltage detector	1134/174
Tether rope with a tension device	54
Threaded adapter	146
Tool bag	52/141
Tool bag for safety harness	52
Trimmer and pruning saw	182
Two-pole phase comparator for indoor and outdoor use	155
<hr/>	
Undergloves	27
Undergloves Nomex III ®	36
Universal pliers	120
<hr/>	
Voltage Detectors and Testers	94/96/98
Voltage detector with leds for indoor use (Compact serie) without batteries	154
Voltage detector with leds for indoor use without batteries	154
Voltage take-off punch	100
Voltage tester for M.V. separable connectors	164
<hr/>	
Wall mounted supports	167/174
Warning flags	91
Warning signs	88
Water pump plier	115/121
Wire Gun Tester	193
Wire stripping plier	114/123
Work Gloves	41
Wall support for palocks	81

References	Pages	References	Pages	References	Pages	References	Pages
A-76230	73	AL-240-S-Z-EX	73	AM-7002	89	CC-265-225/550-Kau-C	187
A2C-10-Z	196	AL-240-V-00-EX	73	AMI-10	196	CC-265-315/765-1-Kau-C	187
A2C-15-Z	196	AL-240-V-111-EX	73	AMI-15	196	CC-265-60/150-Kau-C	187
A3MC-10-Z	196	AL-240-V-Z-EX	73	AP-499/1	79	CC-265-63/150-(*)	187
A3MC-15-Z	196	AL-240-Z-EX	73	AP-499/1	88	CC-265-63/90-(*)	187
AC-10-Y	196	AL-260-(**)-EX	73	AP-510-BT-GB	88	CC-265-90/225-(*)	187
AC-15-Y	196	AL-260-00-EX	73	AP-510-GB	89	CC-365-10/30-(*)	171
AC-20-Y	196	AL-260-S-(**)-EX	73	AP-951/2	89	CC-365-101	171
AC-21	92	AL-260-S-00-EX	73	AT-41/025	90	CC-365-3/1-(*)	171
AC-44	92	AL-260-S-Z-EX	73	AT-41/05	90	CC-45-K	164
AD-01	92	AL-260-Z-EX	73	AT-41/1	90	CC-765-10/30	170
AL-127	92	AL-31	92	AT-49/025	90	CC-765-10/30-(*)	152
AL-129	92	AL-31/05	92	AT-49/05	90	CC-765-10/36	170
AL-138	92	AL-31/25	92	AT-49/1	90	CC-765-10/36-(*)	152
AL-200	77	AL-316	91	AT-50/025	90	CC-765-3/10	170
AL-201-C/1	78	AL-318	91	AT-50/053	90	CC-765-3/10-(*)	152
AL-201/1	78	AL-32/05	92	AT-50/1	90	CC-765-44/132	186
AL-202	77	AL-32/25	92	AT-5005	92	CC-765-55/20	170
AL-203*	77	AL-321	91	AT-51/025	90	CC-765-55/20-(*)	152
AL-204	79	AL-322	91	AT-51/05	90	CC-965-10/30	153
AL-205	78	AL-323	91	AT-51/1	90	CC-965-5/15	153
AL-205/5	78	AL-324	91	AT-52/05	90	CD-124	165
AL-206	80	AL-53	91	AT-52/1	90	CD-128	165
AL-208-C *	78	AL-58	91	AT-53/1	90	CE-3-24-C	161
AL-208-D **	78	AL-60	91	AT-54/05	90	CE-4-21-	152
AL-209-L	79	AL-62-A	92	AT-54/1	90	CE-4-21-(*)	161
AL-212	80	AL-63-A	92	AT-55/05	90	CE-4-21-(*)	174
AL-216	78	AL-65-A	92	AT-55/1	90	CE-4-30-C	161
AL-230-(**)-EX	73	AL-B-111-EX	73	AT-56/05	90	CE-4-30-C	174
AL-230-S-(**)-EX	73	ALM-20/45	77	AT-56/1	90	CE-5-105-X	60
AL-230-S-Z-EX	73	ALM-6/25	77	AT-58/05	90	CE-5-105-X	161
AL-230-Z-EX	73	ALM-6/38	77	AT-58/1	90	CE-5-105-X	174
AL-236-00-EX	80	ALM-6/8	77	AT-59/05	90	CE-5-50-X	60
AL-236-111-EX	80	ALP-03	76	AT-59/1	90	CE-5-50-X	161
AL-236-222-EX	80	ALP-06	76	AT-60/05	90	CE-5-50-X	174
AL-236-S-00-EX	80	ALP-12/2M	76	AT-60/1	90	CE-5-60-X	60
AL-236-S-111-EX	80	ALP-4/3	76	AT-61/05	90	CE-5-60-X	161
AL-236-S-222-EX	80	ALP-4/6	76	AT-61/1	90	CE-5-60-X	174
AL-240-(**)-EX	73	AM-20-GB	88	AT-62/05	90	CE-5-70-X	60
AL-240-B-00-EX	73	AM-20-RM	89	AT-62/1	90	CE-5-70-X	161
AL-240-B-Z-EX	73	AM-282/2-RM	89	AT-63/05	90	CE-5-70-X	174
AL-240-BL-00-EX	73	AM-32/3	89	AT-63/1	90	CE-5-90-X	60
AL-240-BL-111-EX	73	AM-33/3	89	BCY	197	CE-5-90-X	161
AL-240-BL-Z-EX	73	AM-34/2	89	C-92-20	155	CE-5-90-X	174
AL-240-J-00-EX	73	AM-344	88	C-92-492	171	CE-75-(*)	161
AL-240-J-111-EX	73	AM-344-GB	88	C2C-10-Z	196	CE-75-(*)	174
AL-240-J-Z-EX	73	AM-344/05	88	C2C-15-Z	196	CF-3-72...-(*)	161
AL-240-S-(**)-EX	73	AM-345-GB	88	C2C95Z	197	CF-3-90...-(*)	161
AL-240-S-B-00-EX	73	AM-41/1	88	CC-10-Y	196	CF-5-110-(*)	174
AL-240-S-B-111-EX	73	AM-41/2	88	CC-127-ERDF-C	107	CF-5-170-(*)	174
AL-240-S-BL-00-EX	73	AM-467-GB	79	CC-15-Y	196	CF-5-40-(*)	161
AL-240-S-BL-111-EX	73	AM-467-GB	88	CC-151-K	164	CF-5-40-(*)	174
AL-240-S-J-00-EX	73	AM-49/1	88	CC-20-Y	196	CF-5-90-(*)	161
AL-240-S-J-111-EX	73	AM-49/2	88	CC-265-150-(*)	187	CF-5-90-(*)	174
AL-240-S-V-00-EX	73	AM-61-GB	89	CC-265-150/420-Kau-C	187	CG-05-(*)	25
AL-240-S-V-111-EX	73	AM-61-RM	89	CC-265-225/420-(*)	187	CG-1-(**)-NR	25

General reference index

References	Pages	References	Pages	References	Pages	References	Pages
CG-1-(**)-NR	25	CL-7-06/18-(*)	172	CM-4625-I	188	KIT-23	116
CG-10-(*)	25	CL-7-10/30-(*)	172	CM-50	162	KIT-23C	117
CG-117	26	CL-7-10/30-1-(*)	172	CM-6-15	191	KIT-23CH	117
CG-2-(**)-NR	25	CL-7-12/36-(*)	172	CM-6-20	191	KIT-23P	117
CG-2-(**)-NR	25	CL-8-05	155	CM-6-25	191	KIT-23PH	117
CG-3-(**)-NR	25	CL-8-36	155	CM-6-30	191	KIT-23S	117
CG-3-(***)-NR	25	CL-8-36/1	155	CM-7-10-A	161	KIT-23SC2	117
CG-35/2	26	CL6-100-30000	156	CM-7-10-A	174	KIT-23SCP	117
CG-36-1	27	CM-02-(*)	182	CM-90	165	KIT-23SH	117
CG-36-2	27	CM-02-(**)	176	COL-32/100	197	KIT-23SP2	117
CG-37	36	CM-03-K	176	COL-8/32	197	KIT-24	116
CG-4-(**)-NR	25	CM-03-K	182	CS-01-C	167	KIT-25	116
CG-4-(***)-NR	25	CM-04-K	182	CS-225	165	KIT-27	116
CG-80-(*)	27	CM-1-10	175	CS-45	165	KIT-ARC-100-B-(*)	40
CG-81	28	CM-1-15	175	CS-90	165	KIT-ARC-12-C-(*)	39
CG-951-(**)	41	CM-1-20	175	CT-7-25/1	33	KIT-ARC-12-J-(*)	39
CG-952-(**)	41	CM-225	165	CT-7-40/1	34	KIT-ARC-12-JP-(*)	39
CG-96-(*)	41	CM-3-03	175	CT-7-63	34	KIT-ARC-25-B-(*)	40
CG-97-C	41	CM-3-04	175	CT-9-25	34	KIT-ARC-40-B-(*)	40
CG-981-(*)	24	CM-3-05	175	CT-9-45	34	KIT-ARC-65-B-(*)	40
CG-981-(*)	27	CM-3-06	175	CT-9-63	34	KIT-CONSI01D GB	86
CG-991-(*)	27	CM-3900-J	188	CX-34211	100	KIT-CONSI01E GB	85
CG-991-(**)	24	CM-4115-(*)	188	CX-35811	100	KIT-CONSI01G GB	85
CGA-0-(*)-B	25	CM-4120-(*)	188	CX-45211	100	KIT-HAUT-01-(*)	50
CGA-00-(*)-B	25	CM-4125-(*)	188	CX-45411	100	KIT-HAUT-02-(*)	50
CGA-1-(*)-NB	25	CM-4130-(*)	188	CX-45511	100	KIT-HAUT-03-(*)	51
CGA-2-(**)-NB	25	CM-4220-(*)	188	CZ-53-MR	167	KIT-HAUT-04-(*)	51
CGA-3-(**)-NB	25	CM-4230-(*)	188	CZ-53-R	167	KIT-HAUT-05	49
CGA-4-(***)-NB	25	CM-4240-(*)	188	CZ-53-R/2	167	KIT-HAUT-06	47
CGM-0-(*)	26	CM-4345-(*)	188	CZ-53MR/2	167	KIT-HAUT-10	47
CGM-00-(*)	26	CM-4360-(*)	188	CZ-54-R	166	KIT-HAUT-11	48
CGM-1-(*)	26	CM-4400-J	175	CZ-54-RM	166	KIT-HAUT-12	48
CGM-2-(*)	26	CM-4410	175	CZ-55-R	166	KIT-HAUT-13	49
CGM-3-(*)	26	CM-4410-(*)	175	CZ-55-RM	166	KIT-M068404DYN	138
CGM-4-(**)	26	CM-4410-I	175	CZ-60	166	M-187	39
CI-06-D	158	CM-4415	175	DT-300	102	M-24-10	179
CI-06-D	164	CM-4415-(*)	175	DT-500	103	M-24-120	179
CI-06-D	167	CM-4415-I	175	GL-100	83	M-24-120-S	179
CI-06-D	174	CM-4420	175	GL-101	83	M-24-150	179
CI-08	167	CM-4420-(*)	175	HL-100	82	M-24-150-S	179
CI-08	174	CM-4420-I	175	HL-101	82	M-24-16	179
CI-10-D	167	CM-4425	175	HL-102	82	M-24-16-S	179
CI-10-D	174	CM-4425-(*)	175	HL-103	82	M-24-25	179
CI-12-D	167	CM-4425-I	175	HL-104	82	M-24-25-S	179
CI-12-D	174	CM-45	165	HL-105	82	M-24-35	179
CI-70	165	CM-4610	188	HL-200	82	M-24-35-S	179
CL-1-06	155	CM-4610-(*)	188	HL-201	82	M-24-35-V	192
CL-40010	156	CM-4610-I	188	HL-202	82	M-24-40	179
CL-465-10/30-2	154	CM-4615	188	HL-203	83	M-24-40-S	179
CL-465-10/30-M	154	CM-4615-(*)	188	KIT-01	151	M-24-50	179
CL-495-3	163	CM-4615-I	188	KIT-02	151	M-24-50-S	179
CL-497-00	163	CM-4620	188	KIT-03	134	M-24-70	179
CL-498-00	164	CM-4620-(*)	188	KIT-04	134	M-24-70-S	179
CL-499/101	164	CM-4620-I	188	KIT-05	134	M-24-95	179
CL-5-03	156	CM-4625	188	KIT-07	134	M-24-95-S	179
CL-5-36	156	CM-4625-(*)	188	KIT-10	151	M-28-120	180

References	Pages	References	Pages	References	Pages	References	Pages
M-28-120	192	MC-120/15	145	MF-66	193	MO-52-L	54
M-28-150	180	MC-120/50	145	MO-052	57	MO-52-P	54
M-28-150	192	MC-121	145	MO-101	140	MO-52020	54
M-28-50	180	MC-122	145	MO-102	140	MO-52021	54
M-28-70	180	MC-123	145	MO-102-D	140	MO-52030-P	60
M-28-70	192	MC-124	145	MO-103	140	MO-52031	60
M-7292	102	MC-141	144	MO-11000	18	MO-52033	60
M-87-153	192	MC-142	144	MO-11000	39	MO-52034	60
M-87-295	192	MC-1421	147	MO-11000	40	MO-52040	55
M-87-53	192	MC-143	144	MO-11001	18	MO-53	57
M-87290	99	MC-144	144	MO-11003	18	MO-53002	56
M-87292	103	MC-145	144	MO-11010	18	MO-53010	56
M-87292	104	MC-146	144	MO-11011	18	MO-54	58
M-87295	39	MC-147	144	MO-134	39	MO-54-D	59
M-87295	40	MC-147/1	144	MO-155	22	MO-54000	58
M-87303	141	MC-148	144	MO-158	41	MO-54002	59
M-87369	95	MC-148/1	144	MO-16A	61	MO-54002/1	59
M-87369	97	MC-149	144	MO-17-01	61	MO-54002/2	59
M-87369	99	MC-153/05	144	MO-17-02	61	MO-54004	58
M-87370	139	MC-153/10	145	MO-17-03	61	MO-54005	59
M-87384	22	MC-153/30	145	MO-17-04	61	MO-54005-C	60
M-87386	33	MC-153/60	145	MO-17-A	61	MO-54005-K	60
M-87387	33	MC-155/05	145	MO-180-ARC-12	37	MO-54010	55
M-87413	39	MC-155/10	145	MO-180-ARC-4	37	MO-54020	55
M-881601	103	MC-155/20	145	MO-182/1-B	20	MO-54040	56
M-881602	103	MC-155/30	145	MO-182/1-B	39	MO-55/1	58
M-881836	22	MC-155/60	145	MO-182/1-B	40	MO-56009	54
M-881837	22	MC-155/80	145	MO-182/1-J	20	MO-56010	54
M-882671	22	MC-181	88	MO-182/1-R	20	MO-563-A(*)	46
M-882677	22	MC-182	88	MO-183-BL	20	MO-565-(*)	46
M-883209	19	MC-182-8M	88	MO-183-RL	20	MO-591000	53
M-883298	19	MC-183	88	MO-185-B	21	MO-591002	53
M-883374	38	MC-184-6F	88	MO-185-BL	21	MO-592002	53
M-883377	38	MC-184-6M	88	MO-185-BLM	21	MO-61	54
M-883378	38	MC-185-10F	88	MO-185-J	21	MO-61001	123
M-883379	38	MC-185-10M	88	MO-185-R	21	MO-61002	123
M-883380	38	MC-296-00/08	109	MO-187	37	MO-64501	124
M-883381	38	MC-296-115/08	109	MO-187/1-B	37	MO-64502	124
M-92-28	182	MC-296-160/08	109	MO-24	61	MO-650-D	118
M-921647	102	MC-296-A	109	MO-25	61	MO-652-D	118
M-95-236	66	MC-296-B	109	MO-26	61	MO-65200D	118
M-951143	99	MC-296-C	109	MO-284	19	MO-65202	118
M-952271	104	MC-296-M	109	MO-284-C	19	MO-65202D	118
M-952325	95	MC-296-NFC	110	MO-286	19	MO-65203	118
M-952325	97	MC-296-P	109	MO-32/3	52	MO-65203D	118
M-952439	99	MD-02	57	MO-34	141	MO-65204	118
M-95626/4	109	MD-03	58	MO-35	61	MO-65204D	118
M-95627/4	109	MD-10-C	182	MO-36	141	MO-65205	118
M-9573	157	MD-12-C	182	MO-36310	128	MO-652055D	118
M611386	107	MD-14-C	182	MO-37	139	MO-65205D	118
M87-290	100	MD-40-B	182	MO-38	139	MO-65206	118
M951961	103	MD-42-B	182	MO-38510	143	MO-65206D	118
M952567	107	MF-60	193	MO-39	139	MO-65207	118
M952568	107	MF-61	193	MO-50	141	MO-652082D	118
M952570	107	MF-62	193	MO-510-03	142	MO-65208D	118
MC-120/100	145	MF-63	193	MO-510-03/2	142	MO-65209	118

General reference index

References	Pages	References	Pages	References	Pages	References	Pages
MO-652102D	118	MO-67304	123	MO-68118	126	MO-68613	127
MO-65210D	118	MO-67305	123	MO-68119	126	MO-68614	127
MO-65211	118	MO-67306	123	MO-68120	126	MO-68620	127
MO-65212D	118	MO-67401	121	MO-68121	126	MO-68621	127
MO-65230	118	MO-67402	121	MO-68122	126	MO-68701	125
MO-65232	118	MO-67404	121	MO-68123	126	MO-68702	125
MO-652321D	118	MO-67500	122	MO-68124	126	MO-68703	125
MO-65232D	118	MO-67501	122	MO-68125	126	MO-68704	125
MO-65233D	118	MO-67502	122	MO-68126	126	MO-68705	125
MO-65234	118	MO-67599	124	MO-68127	126	MO-68713	127
MO-65234D	118	MO-67600	124	MO-68128	126	MO-68714	127
MO-65236	118	MO-67601	124	MO-68129	126	MO-68717	127
MO-65236D	118	MO-67611	124	MO-68130	126	MO-68719	127
MO-65238	118	MO-67700	122	MO-68132	126	MO-68721	127
MO-65238D	118	MO-67701	122	MO-68205	126	MO-69/10	52
MO-65240	119	MO-68/10	52	MO-68206	126	MO-69/15	52
MO-652405D	119	MO-68/15	52	MO-68207	126	MO-69/20	52
MO-652406D	119	MO-68006	126	MO-68209	126	MO-69002	125
MO-652410D	119	MO-68007	126	MO-68210	126	MO-69003	125
MO-65242	119	MO-68008	126	MO-682101	126	MO-69004	125
MO-65244	119	MO-68008/19	126	MO-682111	126	MO-69005	125
MO-652441D	119	MO-68009	126	MO-682121	126	MO-69050	133
MO-65244D	119	MO-68010	126	MO-682131	126	MO-69051	133
MO-65245D	119	MO-68011	126	MO-682141	126	MO-69054	133
MO-65246	119	MO-68012	126	MO-682151	126	MO-69210	125
MO-65246D	119	MO-68013	126	MO-682161	126	MO-69213	125
MO-65248	119	MO-68014	126	MO-682171	126	MO-69216	125
MO-65248D	119	MO-68015	126	MO-682181	126	MO-69217	125
MO-653-D	118	MO-68016	126	MO-682191	126	MO-69218	125
MO-65405	119	MO-68017	126	MO-682211	126	MO-69219	125
MO-65406	119	MO-68018	126	MO-682221	126	MO-69306	128
MO-65505	119	MO-68019	126	MO-682231	126	MO-69307	128
MO-65506	119	MO-68020	126	MO-68224	126	MO-69308	128
MO-66000C	121	MO-68021	126	MO-68226	126	MO-69308/23	132
MO-66001	120	MO-68022	126	MO-68227	126	MO-69308/30	135
MO-66002	120	MO-68023	126	MO-68228	126	MO-69308/30US	135
MO-66003	120	MO-68024	126	MO-68229	126	MO-69308/31	135
MO-66005	120	MO-68025	126	MO-68230	126	MO-69308/32	136
MO-66102	120	MO-68026	126	MO-68232	126	MO-69308/33	136
MO-66105	120	MO-68027	126	MO-68310	127	MO-69309	128
MO-66202	120	MO-68028	126	MO-68311	127	MO-693100	128
MO-66300	120	MO-68029	126	MO-68312	127	MO-69311	128
MO-66301	120	MO-68030	126	MO-68313	127	MO-69312	128
MO-66302	120	MO-68032	126	MO-68314	127	MO-69313	128
MO-66303C	121	MO-68106	126	MO-68316	127	MO-69314	128
MO-66402	120	MO-68107	126	MO-68317	127	MO-69315	128
MO-66404	120	MO-68108	126	MO-68319	127	MO-69316	128
MO-66404CC	121	MO-68109	126	MO-68321	127	MO-69317	128
MO-66500	121	MO-68110	126	MO-68322	127	MO-69318	128
MO-66502	121	MO-68111	126	MO-68402	114	MO-69319	128
MO-66505	121	MO-68112	126	MO-68403	114	MO-69321	128
MO-67101	122	MO-68113	126	MO-68404	114	MO-69322	128
MO-67102	122	MO-68114	126	MO-68405	114	MO-69323	128
MO-67103	122	MO-68115	126	MO-68406	114	MO-69324	128
MO-67302	123	MO-68116	126	MO-68408	114	MO-69393	128
MO-67302C	123	MO-68117	126	MO-68610	127	MO-69394	128

References	Pages	References	Pages	References	Pages	References	Pages
MO-69395	128	MO-69610	127	MO-69T30	128	MP-100/05-10	32
MO-69396	128	MO-69611	127	MO-69T40	128	MP-100/05-5	32
MO-69397	128	MO-69612	127	MO-69T50	128	MP-100/10-10	32
MO-69398	128	MO-69613	127	MO-70	45	MP-100/10-5	32
MO-694-1-1/16SAE	130	MO-69614	127	MO-70-ISO	45	MP-11/11	32
MO-694-1-1/4	130	MO-69615	127	MO-71	47	MP-11/16	32
MO-694-1-1/8	130	MO-69616	127	MO-72-ATEX	45	MP-120/03-1	32
MO-694-1-3/16SAE	130	MO-69617	127	MO-72002	113	MP-123	69
MO-694-1/2SAE	130	MO-69618	127	MO-72003	113	MP-123/1	69
MO-694-11/16	130	MO-69619	127	MO-72004	113	MP-123/2	69
MO-694-13/16	130	MO-69621	127	MO-72005	113	MP-19-LOT	70
MO-694-15/16	130	MO-69622	127	MO-72006	113	MP-211	181
MO-694-1SAE	130	MO-69623	127	MO-72008	113	MP-212	181
MO-694-1SAE	130	MO-69624	127	MO-72010	113	MP-213	181
MO-694-3/4	130	MO-697-1/4SAE	128	MO-72030	113	MP-213/EXT	181
MO-694-3/8	130	MO-697-15/16	128	MO-72032	113	MP-213/LAM	181
MO-694-5/8	130	MO-697-1SAE	128	MO-72034	113	MP-22	67
MO-694-7/16	130	MO-697-5/16	128	MO-72036	113	MP-220	69
MO-694-7/8	130	MO-697-7/8	128	MO-72038	113	MP-220/1	69
MO-694-9/16	130	MO-69735	128	MO-72040	113	MP-23	67
MO-69408/23	132	MO-69736	128	MO-72042	113	MP-26-A	67
MO-69408/30	136	MO-69737	128	MO-72044	113	MP-26-B	67
MO-69408/30US	137	MO-69738	128	MO-72046	113	MP-26-C	67
MO-69408/31	137	MO-69739	128	MO-72048	113	MP-26-D	67
MO-69423	130	MO-69740	128	MO-720510	113	MP-26-E	67
MO-69424	130	MO-69741	128	MO-720515	113	MP-31	67
MO-69425	130	MO-69742	128	MO-720520	113	MP-32/10	67
MO-69426	130	MO-69804	129	MO-720525	113	MP-32/15	67
MO-69427	130	MO-69804/23	137	MO-720527	113	MP-33	67
MO-69428	130	MO-69804/23US	138	MO-720530	113	MP-35	69
MO-69429	130	MO-69805	129	MO-720540	113	MP-35/12	69
MO-69430	130	MO-698055	129	MO-720545	113	MP-37	69
MO-69432	130	MO-69806	129	MO-720550	113	MP-40	69
MO-694M04	130	MO-69807	129	MO-72056	113	MP-400	66
MO-694M05	130	MO-69808	129	MO-72057	113	MP-400-2	66
MO-694M06	130	MO-69809	129	MO-72058	113	MP-402-MB	66
MO-694M08	130	MO-69810	129	MO-72059	113	MP-402-MI	66
MO-694M10	130	MO-69811	129	MO-72100E	133	MP-403-MB	66
MO-694M12	130	MO-69812	129	MO-72102	114	MP-403-MI	66
MO-694M14	130	MO-69813	129	MO-72122	115	MP-4110	70
MO-694M17	130	MO-69814	129	MO-72132	115	MP-41530	70
MO-694M19	130	MO-698M03	129	MO-72142	115	MP-42/11	32
MO-69512	133	MO-698M04	129	MO-72155	115	MP-42/16	32
MO-69513	133	MO-698M05	129	MO-72162	115	MP-42/66	32
MO-69514	133	MO-698M06	129	MO-72172	114	MP-46500	64
MO-69522	129	MO-698M07	129	MO-72200	114	MP-46501	64
MO-69524	130	MO-698M08	129	MO-831	66	MP-50	67
MO-69534	130	MO-69903	125	MO-832	66	MP-501-D	66
MO-69535	131	MO-69904	125	MO-87413	37	MP-502-D	66
MO-69536	131	MO-69905	125	MO-98208	126	MP-503-D	66
MO-69537	131	MO-69906	125	MP-01	33	MP-506/2	63
MO-69539	131	MO-69908	125	MP-02	33	MP-508/2	63
MO-69540	129	MO-69910	125	MP-100/02-10	32	MP-509/2	63
MO-69608	127	MO-69912	125	MP-100/03-10	32	MP-510/2	63
MO-69608DYN	138	MO-69T15	128	MP-100/03-5	32	MP-510/2-IQ	63
MO-69609	127	MO-69T20	128	MP-100/05-1	32	MP-514/2	63

General reference index

References	Pages	References	Pages	References	Pages	References	Pages
MP-515/2R	63	MT-2950/35	160	MT-815-S	159	MV-232-*	30
MP-59	67	MT-2951	160	MT-817-C	159	MX-215	183
MP-60/03-10	32	MT-2951/1	160	MT-818-C	159	MX-400	147
MP-60/03-5	32	MT-2951/2	160	MT-834-E	190	MX-400/1	147
MP-60/05-1	32	MT-3950/35	160	MT-834-H	190	MX-400/6	147
MP-60/05-10	32	MT-3951	160	MT-834-T	190	MX-400/7	147
MP-60/05-5	32	MT-3951/1	160	MT-835-E	190	MX-404	163
MP-602-D	62	MT-3952	160	MT-835-H	190	MX-430-M	198
MP-603-D	62	MT-3952/1	160	MT-835-T	190	MX-433-T	197
MP-604-D	62	MT-40	180	MT-837-E	190	MX-433-T	198
MP-605-D	62	MT-404	106	MT-837-H	190	PL-100	81
MP-607/2-1	63	MT-405	106	MT-837-T	190	PL-101	81
MP-607/3-1	63	MT-406	106	MT-840	159	PL-102	81
MP-608/2-1	63	MT-407	106	MT-840/1	159	RL-100	81
MP-608/3-1	63	MT-508/36	178	MT-840/1	177	SJ-12-2XL	38
MP-609/2-1	63	MT-508/46	178	MT-8408	158	SJ-12-L	38
MP-620-D	62	MT-509/3	107	MT-841	159	SJ-12-M	38
MP-624/2-D	62	MT-509/3EP	107	MT-843	177	SJ-12-S	38
MP-625-D	70	MT-509/3VAT	107	MT-843	191	SJ-12-XL	38
MP-627-D	70	MT-546	107	MT-843-P	191	SL-101	84
MP-634/2-D	62	MT-5805	158	MT-847	191	SL-102	84
MP-700-1	64	MT-615/1-7,5	108	MT-852	191	SO-10	53
MP-700-100	65	MT-615/2-7,5	108	MT-853	191	TO-2-16	197
MP-700-2	64	MT-630-C	177	MT-890	158	TO-2-19	197
MP-700-200	65	MT-630-K	177	MT-891	158	TO-3-16/19	197
MP-700-3	64	MT-630-S	177	MT-893	158		
MP-700-4	64	MT-633-C	177	MT-895	158		
MP-700-5	64	MT-633-K	177	MT-920-E	160		
MP-700-6	65	MT-633-S	177	MT-925-E	160		
MS-124/2	22	MT-634-C/K	177	MT-934	190		
MS-126	22	MT-634/1-C/K	177	MT-935	190		
MS-152-X	100	MT-635/1-C/K/S	177	MT-951/1	160		
MS-62	101	MT-640-S	177	MT-951/2	160		
MS-63	101	MT-641-S	177	MT-951/3	160		
MS-8013-2	99	MT-650	108	MT-952/1	160		
MS-917-L	95	MT-650	177	MT-952/2	160		
MS-917-VE	98	MT-6613	173	MT-952/3	160		
MS-918-L	95	MT-6613/1	173	MT-953/08	160		
MS-920-EX	97	MT-70/1	180	MT-953/12	160		
MT-1910	157	MT-701/1	193	MT-955/08	160		
MT-1911	157	MT-731-(*)	189	MT-955/12	160		
MT-1911-E	157	MT-732-(*)	189	MT-956	160		
MT-1920	157	MT-734-(**)	189	MT-9801	158		
MT-1921	157	MT-735-(*)	189	MV-104/(*)	41		
MT-1921-E	157	MT-735-P4	192	MV-105-(*)	38		
MT-1951/10	160	MT-737-H	189	MV-123-(*)	41		
MT-1951/12	160	MT-790	192	MV-124-(*)	41		
MT-205	108	MT-792	192	MV-136-	28		
MT-206	108	MT-797	192	MV-136B-	28		
MT-207	108	MT-811-C	159	MV-137	28		
MT-222	108	MT-812-C	159	MV-138/	28		
MT-223	108	MT-813-C	159	MV-222-	29		
MT-242	106	MT-814/2	159	MV-223-	29		
MT-244	106	MT-814/3	159	MV-226-	29		
MT-245	106	MT-815-C	159	MV-227-	29		
MT-249	106	MT-815-E	159	MV-228-	29		

IEC Standard

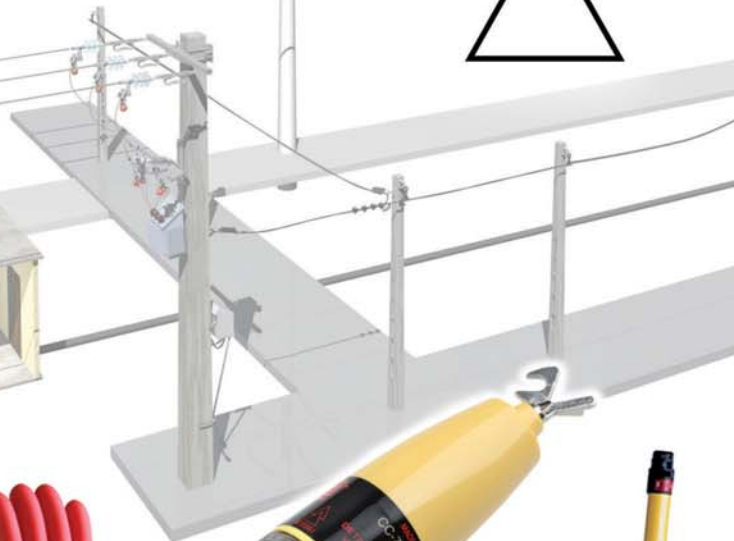

International Electrotechnical Commission is a worldwide organization for standardization comprising national electrotechnical committees (NC). The object of the IEC is to promote international cooperation on all questions concerning standardization in the electrical fields. These standards have been approved by more than 50 different countries including Australia, Canada, China, France, Germany, Japan, Russia, Malaysia, Singapore, Mexico, India, Indonesia, South Africa, New Zealand, USA...



A rapid need to perform electrical operations evolved with the time.

This resulted in regional or national working on specific standards without coordination.

IEC standards were developed according to a consensus procedure and approved by recognized body. They provide an adequate answer at worldwide level.

The IEC standard presents benefits to all parties involved:

- for the end-users: it is the guarantee of a suitable and internationally recognized quality equipment,
- for the Testing Laboratories: it determines better standards of testing and control procedures for materials,
- for the manufacturers: it helps them to make a better technico-commercial offer.

CATU Designs, tests and manufactures under the IEC requirements.

CATU Is the first manufacturer to provide a full range of products complying with the IEC standards.

CATU Shows its innovation ability for the welfare of the electrical world.



Personal and collective protective equipment



Eyes protection	18
Head Protection	20
Insulating rubber gloves	23
Insulating boots	28
Insulating mats	31
"Arc Flash" protection	35
Workwear and other protections	42
Work at height	44
Insulating flexible blanket	68





Accréditation n°1-0897
Portée disponible sur
www.cofrac.fr



ISO 9001 - ILO-OSH 2001
OHSAS 18001 - ISO 14001



SERVICES

- Testing laboratory
- Flexible workshop
- Training
- After sales services
- Technical assistance

After Sales Services

xavier.lebec@catuelec.com

Phone: +33 01 42 31 46 85 - Fax: 01 42 31 46 45

latif.ozmen@catuelec.com

Phone: +33 01 42 31 46 86 - Fax: 01 42 31 46 45

Technical assistance

corinne.peigne@catuelec.com

Phone: +33 01 42 31 46 24 - Fax: 01 42 31 46 34

germain.molis@catuelec.com

Phone: +33 01 42 31 46 13 - Fax: 01 42 31 46 34



Key advantages in risk prevention.

PPE : Personal Protective Equipment.

PPE are defined as any device or means intended to be worn or held by one person to protect itself against one or several risks liable to threaten its safety or its security.

CPE : Collective protective equipment.

Collective protective equipment for preventing electrical hazards contains all the products that close off the hazard by:

- Distance (marking, signs),
- Obstacles (covers, screen, barrier),
- Insulation (insulating blankets, insulating caps, etc.).

CPE must comply with the standards in force.

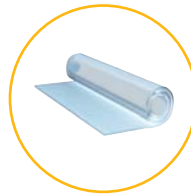

PPE within the framework of electrical safety recommendations.

"Personal Protective Equipment is used to protect individuals who work on or near an installation that presents an electrical hazard." Equipment complying with the standards in force and appropriate for the type of operation and voltage level of the installation must be used.

PPE check

- Every PPE must be verified at least visually before and after every use.
- Regular tests must be made by qualified persons and at least annually.
- If the slightest doubt exists the equipment must be reformed and replaced at once.



THE RESPONSIBILITY OF THE EMPLOYER

- To give free of charge and in a personal way equipment necessary and adapted to the risks,
- To watch over their actual use,
- To ensure the necessary replacement as well as the maintenance and the compliance,
- To inform the users of the risks against whom they are protected.

REGULATIONS

The personal protective equipment have to be in compliance with the requirements of the European Directive :

89/391/CEE, on the introduction of measures to encourage improvements in the safety and health of workers at work.

89/655/CEE and **89/656/CEE**, on the minimum health and safety requirements for the use by workers of personal protective equipment at the workplace.

89/686/CEE, on the approximation of the laws of the Member States relating to personal protective equipment (CE marking).



- In practice, they define:
- The protections adapted to the kind of risk,
 - The highest level of protection possible,
 - The comfort, the ergonomics and the quality of the equipment,
 - The annual verification of PPE by a competent individual.

The obligations for using PPEs in companies are defined by the European Directive 89/656.



Eyes protection

SAFETY GLASSES

Protection against UV radiation and ejections of solid particles.

CAUTION: DO NOT USE FOR WELDING OPERATIONS.

Reference	Characteristics	UV protection	Resistance
MO-11000	Clear lenses	99.5 % < 370 nm	Level F Impact: 6 mm steel ball launched at 45 m/s
MO-11001	Tinted lenses	99.5 % < 370 nm	
MO-11003*	Tinted lenses	99.5 % < 370 nm	

* EN 169 - 80 °C - FT HTA N°127.

THE +

- 1 Grilamid frame.
- 2 Polycarbonate lense with a large field of vision. Anti-scratch, anti-impact and anti-chemical product treatments.

EN 166 / EN 170
CE



EN 166 / EN 170
CE

OVERGLASSES

Polycarbonate overglasses. Protection against UV radiation and ejections of solid particles.

CAUTION: DO NOT USE FOR WELDING OPERATIONS.

Reference	Characteristics	UV protection	Resistance
MO-11010	Clear lenses	100 % 180 < 400 nm	Level F Impact: 6 mm steel ball launched at 45 m/s
MO-11011	Green tinted lenses	100 % 180 < 400 nm	

THE +

- 1 One piece wraparound protection that can be worn over eyeglasses.
- 2 Polycarbonate lens and frame with a panoramic field of vision.



ARC FLASH SHIELD WITH HEAD BAND



Protective screen that can be used without a helmet.

Marking: 2C-1.2CATU 1B8-1-03CE1883

Polycarbonate face shield.

- Protection against electric arcs of short-circuits class1.
- Head fit adjustment by milled wheel.
- Anti-scratch and anti-mist treatment.

CAUTION: DO NOT USE FOR WELDING OPERATIONS.

Reference	Characteristics	 mm	 g
MO-286	Clear face shield	230 L x 290 H	400
MO-883209	Replacement face shield		
M-883298	Sweatband		

THE

- 1 Insulating up to 1000 V.
- 2 Arc Flash class1.

IEC 61482-1-2 / GS-ET-29
ANSI Z87.1

CE



EN 166 / EN 170

CE

FACE SHIELD

Protection against electric short-circuit arcs. Face shield adjustable on MO-182 helmet.

I2C-1.2CATU 1B8-1-03CE1883

CAUTION: DO NOT USE FOR WELDING OPERATIONS.

Reference	Fitting
MO-284	Rubber headband
MO-284-C	Side clips

THE

- 1 with all type of helmet.
- 2 ARC Flash class1.
- 3 Isolating up to 1000 V.



Face shield on helmet
MO-182/1-B.



Head protection

EN 397 440 V
 EN 50365 Δ 1 000 V
 ANSI Z89.1 20 000 V
 CE



ABS HELMET

Safety industrial helmet. Standard sizes 53 to 63. Leather trim 21 cm along the inside for added comfort. Multiple adjustments for a perfect fit headband.

Reference	Color	 g
MO-182/1-B	WHITE \circ	300
MO-182/1-R	RED \bullet	300
MO-182/1-J	YELLOW \bullet	300

THE \oplus

- 1 Deformable shock-resistant ABS helmet with a "gutter" brim.
- 2 Size from 53 to 62 cm. Safety chin strap
- 3 Side slots for mounting hearing protection.
- 4 Built-in cushion for optimum ventilation.

POLYCARBONATE HELMET

Protects against vertical and side impacts, very well ventilated. Improved comfort. Adjustable size from 53 to 63 cm.

Reference	Color	 g
MO-183-BL	WHITE \circ	455
MO-183-RL	RED \bullet	455

THE \oplus

- 1 Deformable shock-resistant helmet in polycarbonate.
- 2 Head fit adjustment by milled wheel.
- 3 Chinstrap with an easy adjustment buckle. Designed to tear if hooked. (< 25 daN).
- 4 6-point cloth lining.



EN 12492
 EN 397 440 V
 EN 50365 Δ 1 000 V
 ANSI Z89.1 20 000 V
 CE

HELMET WITH BUILT-IN FACE SHIELD

Industrial helmet with integrated face shield. Approved for protecting against the thermal energy of an electric arc.

Reference	Color	Anti UV
MO-185-BL	WHITE ○	2-1.2
MO-185-R	RED ●	2-1.2
MO-185-J	YELLOW ●	2-1.2
MO-185-B	BLUE ●	2-1.2
MO-185-BLM	WHITE ○ + Chinstrap with a chin	2-1.2

THE +

- 1 Head fit adjustment by milled wheel. Size from 52 to 66 cm.
- 2 Adjusting the height position.
- 3 Panoramic face shield in non-scratch and anti-mist polycarbonate.
- 4 Chinstrap (with Velcro fastening).



MO-185-R



MO-185-J



MO-185-B



Class E20kV as per ANSI Z89-1
Equivalent class 1-7.5kV as per IEC standard
Protection tests against thermal hazards of an electric arc
IEC 61482-1-2 GS-ET-29 Class 1

EN 397
EN 50365 ▲



ACCESSORIES
PAGE 22

HELMET
"ARC FLASH"
PAGE 37



Dimensions



Weight



Head protection

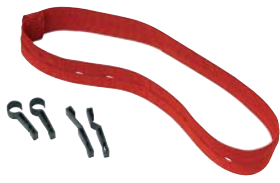

M-881837



M-881837



M-87384



MO-155

ACCESSORIES FOR HELMET

Swivelling head.

Band : choice of standard fabric or rubber for greater stability of the lamp on the helmet.

Reference	Characteristics
M-882677	Spare shield MO-185
M-881836	Spare frontal padded band for MO-185
M-882671	Spare padded headband chinstrap MO-185
M-881837	RED headband
M-881838	White/red velcro for identification
M-87384	Bag for MO-182, MO-183, MO-284, MO-185 and MO-286 Black fabric cover for transporting and protecting helmets and shields
MO-155	Noise-cancelling shell with adapter for mounting on helmets MO-182/1.

HEADLAMP FOR HELMET

Headlamp for helmets MO-185, MO-180-ARC and MO-182/1. Compatible with the majority of helmets on the market

THE +

- 1 Autonomy at full power : 100 hrs.
- 2 Maximum light output : 70 lumens/35 m.
- 3 Textile headband for use as a single headlamp. Supplied with universal adhesive support(1) for helmet (suitable for MO-185, MO-180-ARC, MO-182...). Light distance at full power : 35 m
- 4 3 lighting modes : max, min and flashing.



Reference	Waterproofness	g
MS-124/2	IPX4	86

Adhesive clip supplied to attach to a helmet.

LED headlamp for Helmets

Can be worn either on the head or on different helmets models :
Approval ATEX

European Category 1 Certificate (Zone 0)

II 1 G Ex ia IIC T4 Ga.

- autonomy : 2 intensities : Strong: 19 h / Weak: 47 h,
- material : ABS – high resistance against Shocks and falls,
- range : 19 to 28 m,
- Strong Lumens : 30 / Weak : 14.

THE +

- 1 Adjustable head.
- 2 Headband: choice of standard fabric or rubber for a firm fit of the lamp on helmets.
- 3 3 white Leds.



Reference	6 LR-61 type	mm	g
MS-126	3 x 1,5 V included	76 x 68 x 44	90

Delivered with batteries and headbands

Insulating rubber gloves

An essential choice for safety!

COMPLIANCE

Insulating gloves offer personal protection against electrical shocks when working on or near live wires. They must comply with the IEC 60903 and EN 60903 standards. As a result, they undergo various voltage, ageing, and mechanical testing.



The gloves are individually tested and sold in a sealed UV protected plastic bag.

CHARACTERISTICS OF SYMBOLS

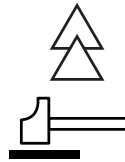

- Label with a double triangle symbol IEC 60 417-5216, suitable for work on live wires.
- Label with a mechanical hammer symbol, indicating additional mechanical properties gloves.



All our gloves provide greater comfort and hygiene when used.



GLOVE TYPES, CLASSES, AND CATEGORIES

There are 2 main types of insulating gloves:

- **Rubber gloves** provide high dielectric performance. They must be used with leather glove covers for mechanical protection.
- **Gloves with mechanical properties** offer superior mechanical protection against punctures and tears. They eliminate the need for overgloves.

ERGONOMIC SHAPE

With an ergonomic shape our gloves are suitable for any type of hand and are soft and supple which allows good dexterity.

A CHOICE OF FULL SIZE

Sizes from 7 to 12 can cover all requirements (Male / Female).

BI-COLOR

Bi-color gloves on class 1/2/3/4 allows contrast to rapidly detect any excessive abrasion, cut, tear and other mechanical surface damage that could alter the dielectric properties of the glove.



CLEAR-MARKING

color label by class.



FLASHCODE

Traceability of the gloves which allows reading test reports.



ROLLED CUFF

Rolled cuff for comfort & ease of handling.





Insulating rubber gloves

Month and year of manufacture

01 - 14

Product code.

Class/ category.

Glove size.

IEC live working symbol.

CE mark and notified body number.

Area for marking first date of use and subsequent test dates.

Manufacturer/ distributor.

Manufacturer lot number.

Voltage level used

Product reference on CE type examination certificate.

IEC standard reference.



CGM-3



Symbol appears only on mechanical gloves.

CONVERSION TABLE FOR INSULATING RUBBER GLOVES AND OVERGLOVES

Gloves	Reference	GLOVES sizes	OVERGLOVES sizes	Overgloves sizes	OVERGLOVES reference
	CG-05- ^(*)	A = 8	8		CG-981- ^(***)
		B = 9	9		
	CG-10- ^(*)	C = 10	10		
		D = 11	11		
	CG-1- ^(**) -NR	7	8		CG-991- ^(***)
		8			
	CG-2- ^(***) -NR	9	9		
	CG-3- ^(***) -NR	10	10		
	CG-4- ^(***) -NR	11	11		
		12	12		

(^{*}) Complete by size codes A=8, B=9, C=10, D=11. (^{**}) Complete by size codes 07 to 12 (sizes 07 and 12 on request). (^{***}) Complete by size codes 08 to 12. (^{****}) Complete by size codes 09 to 12.

INSPECTION AND STORAGE OF INSULATING GLOVES



All insulating gloves must be visible inspected after inflation and before each use.

For Classes 0 and 00: The tests consist of an air inflation test and a visual inspection when the glove is inflated. The dielectric test is not required, but it may be performed at the owner's request.

For Classes 1, 2, 3, and 4: Even when in storage, a glove should be used without having been tested within the last six months. Normal testing periods are between 30 and 90 days.

An inspection of the inside of the gloves is also recommended. Gloves should be stored in their packaging, without being compressed or folded. They should not be stored near a heat source with a temperature of 10 to 21°C.

ASTM INSULATING RUBBER GLOVES

Insulating rubber gloves offer personal protection against electrical shocks when working on or near live wires. Our gloves comply with the ASTM standard (ASTM D 120). The acceptance levels for mechanical tests are stricter. Our gloves are made of rubber especially treated to obtain high dielectric characteristics and they are individually tested and sold in an individual packaging.

Reference	Class	Voltage (AC)	Inch	Color
CGA-00-(*)-B	00	≤ 500 V	14	Black
CGA-0-(*)-B	0	≤ 1 000 V	14	
CGA-1-(*)-NB	1	≤ 7 500 V	14	Bi-colour: Black outside. Natural inside.
CGA-2-(**)-NB	2	≤ 17 000 V	14	
CGA-3-(**)-NB	3	≤ 26 500 V	14	
CGA-4-(***)-NB	4	≤ 36 000 V	16	

(*) Complete by size codes 07 to 12 (sizes 7 and 12 on request).
 (**) Complete by size codes 08 to 12. (***) Complete by size codes 09 to 12.



ASTM D120
Type I



INSULATING RUBBER GLOVES

Gloves without mechanical protection for use with silicon leather glove covers.

Reference	Class	Voltage (AC)	Category	↔ mm	Color
CG-05-(*)	00	≤ 500V	AZC	360	Natural
CG-10-(*)	0	≤ 1 000V	AZC	360	

(*) Complete by size codes A=8, B=9, C=10, D=11.



IEC 60903
EN 60903



Reference	Class	Voltage (AC)	Category	↔ mm	Color
CG-1-(*)-NR	1	≤ 7 500 V	AZC	360	Bi-colour: Red outside. Natural inside
CG-2-(**)-NR	2	≤ 17 000 V	RC	360	
CG-3-(**)-NR	3	≤ 26 500 V	RC	360	
CG-4-(***)-NR	4	≤ 36 000 V	RC	410	

(*) Complete by size codes 07 to 12 (sizes 07 and 12 on request). (**) Complete by size codes 08 to 12. (***) Complete by size codes 09 to 12.

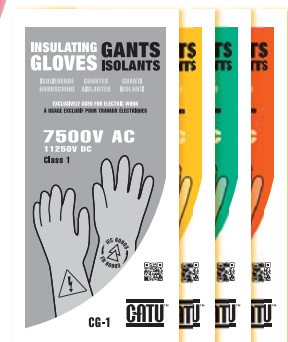

Dimensions Weight Total length



Insulating gloves

MECHANICAL GLOVES

Insulating gloves with higher mechanical properties for working in full safety without leather overgloves.

Reference	Class	Voltage (AC)	Category	↔ mm	Color
CGM-00-(*)	00	≤ 500V	RC	360	Bi-colour: Orange outside. Natural inside.
CGM-0-(*)	0	≤ 1 000V	RC	360	
CGM-1-(*)	1	≤ 7 500V	RC	360	
CGM-2-(**)	2	≤ 17 000V	RC	360	
CGM-3-(**)	3	≤ 26 500V	RC	360	
CGM-4-(***)	4	≤ 36 000V	RC	410	

(*) References to be completed by size 07, 08, 09, 10, 11, 12 (07 and 12 on request).

(**) References to be completed by size 08, 10, 11, 12

(***) size 09, 10, 11, 12



EN 60903 / IEC 60903 ⚡



IEC 61482-1-2 class 2
(Box : 7kA/30cm)



PNEUMATIC GLOVE TESTER

For compulsory control of gloves before use. Checking is done by inflating and immersing in water.

Reference	Characteristics	g
CG-117 *	Pneumatic glove tester	600

* Delivered in cardboard 140 x 150 x 160.

GLOVES BOX

Specially designed for protecting insulating gloves.
Can be fixed on wall.

Reference	mm	g
CG-35/2 *	101 x 224 x 476	900

* Includes a bottle of talcum powder and precautions for use on tape positioned according to the language (English, French, Spanish, German, Italian, Portuguese, Arabic dutch, Chinese, Russian).

THE ⊕

- 1 Velcro buckle for holding gloves upright.
- 2 The transparent cover enables to check gloves presence. UV resistant.
- 3 Recommended maintenance reminders.





INSULATING GLOVES

Made of reinforced waterproof fabric for transport of rubber gloves in vehicles and tool boxes.

Reference	Class	mm	g
CG-36-1	00 to 1	420 x 180	185
CG-36-2	2 to 4	460 x 200	225

THE +

- 1 Dimensions suitable for various glove thicknesses.
- 2 Transparent pocket at the back and loop for belt and hook.



3122

EN 388 / IEC 388
EN 420
CE

CG-981

CG-991

2121

OVERGLOVES

Mechanical and electric arc protection.

Reference	Size	g
CG-981-(*) for insulating gloves class 0 and 00	8	160
	9	
	10	
	11	
CG-991-(*) for insulating gloves to class from 1 to 4	8	200
	9	
	10	
	11	
	12	

(* References to be completed by size A, B, C or D. See the conversion table page 24 for the correct size based on the insulated glove.

THE +

- 1 Silicon grain leather, very flexible. With velcro.
- 2 Large protective cuff in chrome tanned hide. With velcro.
- 3 Silicon goat grain leather.

UNDERGLOVES NOMEX III® "ARC FLASH" PAGE 36

UNDERGLOVES

These washable cotton undergloves improve the use of the insulating gloves. They bring the best held, hygiene and a greater comfort. Washable cotton undergloves.

Reference	Size	g
CG-80-(*)	H = Men	28
	F = Women	

(* References to be completed by size H or F.



Dimensions Weight

PPE - CPE / Insulating gloves





MITTENS

Fingerless gloves shape allowing to keep the maximum of dexterity.

Reference	Size	
CG-81	One size	20

THE +

- 1 Cotton mittens, limit the effects of perspiration and its fingerless gloves shape allowing to keep the maximum of dexterity.

INSULATING BOOTS

Provide electrical insulation protecting "step voltages." No metallic element.

Reference	Size	Class	Voltage
MV-136J-*	39 to 49	0	1 000 V AC
MV-136B-*		0	1 000 V AC
MV-137		-	Tested 20KV AC

* Add size to the reference. Ex: MV-137-43.

THE +

- 1 Provides protection against step voltage.
- 2 For agribusiness application.
- 3 Design to prevent clogging.
- 4 Non-slip vulcanized rubber.



EN 20345
EN 50321 
CE

MV-136J / MV-137

MV-136B

EN 20345
EN 50321 
CE

INSULATING OVER SHOES

Overshoes which provide electrical insulation to protect operators against the risk of a current flow from the feet to the ground or a step voltage. Adapted to a temporary and frequent use.

Reference	Size
MV-138/*	M (39 to 42), L (43 to 45), XL (46 to 48)

* Indicate the size.

THE +

- 1 Classe 0: 1 kV AC - 1.5 kV DC.
- 2 Can be used on footwear.
- 3 Provide protection against « step voltage » ≤ 20kV.



SAFETY SHOES WITH INSULATING SOLE FOR INDOOR AND DRY ENVIRONMENT

Shoe with leather and breathable liner microphone. Anti-perforation textile sole. Protection cap 200J. Adhesion: SRC. Torsion resistant sole.

Reference	Type	Size	Class	Use
MV-222-*	Low	39 to 47	0: 1 000 V (AC)	Industry, construction, bold and smooth floors
MV-223-*	High	39 to 47	0: 1 000 V (AC)	

* Add size to the reference. Ex: MV-222-43.

Shoes with polyurethane rod and antibacterial lining, ventilated 3D mesh neighborhoods. Anti-perforation textile sole. Protection cap 200J. Adhesion: SRC.

Reference	Type	Size	Class	Use
MV-226-*	Low	39 to 47	0: 1 000 V (AC)	Industry, logistics and transport, services and communities.
MV-227-*	High	39 to 47	0: 1 000 V (AC)	

* Add size to the reference. Ex: MV-226-43.

THE +

- 1 Insulating insoles tested at 5 kV and anti perforation.
- 2 To 5 kV according to EN 50321, to 14 kV according to ASTM F2412, to 18 kV according to ASTM F2413



MV-223



MV-222



MV-226

100% TESTED
5 KV



MV-227



EN 20345



SAFETY SHOES WITH INSULATING SOLE FOR INDOOR CONTROLLED ENVIRONMENT

Low shoes with anti-bacterial and calendered nonwoven lining waterproof leather upper. Anti-perforation textile sole. Protection cap 200J. Adhesion: SRC. Torsion resistant sole.



Reference	Type	Size	Class	Use
MV-228-*	Low	39 to 47	0: 1 000 V AC	Condition of strict hygiene, agribusiness. Controlled environment.

Add size to the reference. Ex: MV-228-43.



Insulating boots

MV LIVE WORKING SAFETY SHOES AGAINST ELECTRICAL HAZARDS OF STEP VOLTAGE

Antiperforation textile (1430N). SBP HRO WRU EFO marking. 100% electrically tested. On network MV, the step voltage calculated by RTE SERECT-EDF is 6 kV.

THESE SAFETY SHOES ARE ESPECIALLY DESIGNED FOR USE IN A DRY AREA. DO NOT USE THEM IF THERE IS A RISK OF MOISTURE ENETRATION.

Reference	Size	Step voltage test
MV-232-*	38 to 48	6 kV

* Add size to the reference. Ex: MV-232-43.

RTE SERECT-EDF: ST HTA 70A Ind. E

EN ISO 20345 : 2011 



THE

- 1 Rear tendon indented soft leather.
- 2 Protective toe cap 240 J (composite).
- 3 Rigid sole ideal for working on ladder and tower.

CATU™

Test laboratory



for all your mechanical and electrical tests

COFRAC : French Accreditation of Certification



Certificate no. 1-0897
Available at
www.cofrac.fr



ISO 9001 - ILO-OSH 2001
OHSAS 18001 - ISO 14001

Insulating mats, make the right choice

IN ACCORDANCE WITH STANDARDS

The insulating mats provide individual and collective protection. In elastomer, they are used to cover the ground for the electrical protection of operators during work or interventions on electrical installations.

In accordance with IEC 61111 
 (Live working tools – insulating mats category C:
 Resistant to very low temperature -40°C)

CHARACTERISTICS OF SYMBOLS



• Label with a double triangle symbol IEC 60 417-5216, suitable for live working.

INSULATING MATS MV CLASS 3/4

MP-42/11



Class.

Marking area showing the date of first use and periodic testing date.

In compliance with IEC 61 111.

Marking IEC or EN.

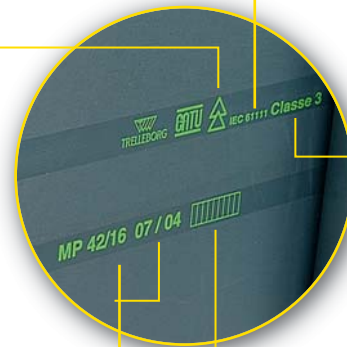



Traceability.

INSULATING MATS LV CLASS 0

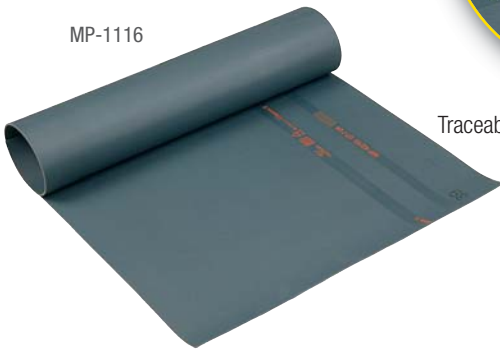
MP-1116



CLASS AND MAXIMUM VOLTAGE

Class	Voltage 	Voltage 
0	1 000 V _{effective}	1 500 V
1	7 500 V _{effective}	11 250 V
2	17 000 V _{effective}	25 500 V
3	26 500 V _{effective}	39 750 V
4	36 000 V _{effective}	54 000 V

Recommendations for use

Storage/Transport

Insulated blanket should be properly stored to avoid the risk of damage to the insulating material. Do not bend insulating mats. Do not store or use close to excessive heat. Do not expose to direct sunlight for long period. Storage temperature : 10°C to 21°C.

Before use

Visually inspected by the user. If the insulating mats is dirty, wash it with soap and water. Dry it with respect of using temperatures.

In use

Operating temperatures : -40°C to 55°C.

Avoid contact with chemical products.

Place the mat on a clean, smooth floor, devoid of aggressive elements for insulation.

Position the feet in the center of the insulating mat.

Periodic inspection





Insulating mats should not be used without having been electrically tested within twelve month preceding with the exception of class 0. Only visual inspection is required for class 0.







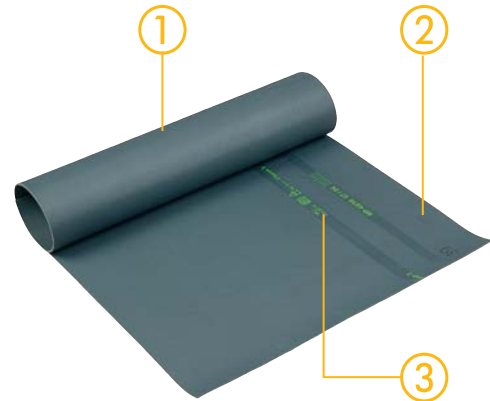

INSULATING MATS LV & MV

Individual models



Reference	Class	Voltage 	Voltage 	Thickness mm	 m	
MP-11/11	0	≤ 1 000 V	≤ 1 500 V	2	1 x 1	2.9
MP-11/16	0	≤ 1 000 V	≤ 1 500 V	2	0.6 x 1	1.4
MP-42/11	3	≤ 26 500 V	≤ 39 750 V	3	1 x 1	4.5
MP-42/16	3	≤ 26 500 V	≤ 39 750 V	3	0.6 x 1	2.9
MP-42/66	3	≤ 26 500 V	≤ 39 750 V	3	0.6 x 0.6	1.8
MP-120/03-1	3	≤ 26 500 V	≤ 39 750 V	3	1.2 x 1	5.8
MP-60/05-1	4	≤ 36 000 V	≤ 54 000 V	5	0.6 x 1	4.4
MP-100/05-1	4	≤ 36 000 V	≤ 54 000 V	5	1 x 1	8.9



For placing in front of panels



Reference	Class	Voltage 	Voltage 	Thickness mm	 m	
MP-100/02-10	0	≤ 1 000 V	≤ 1 500 V	2	1 x 10	29
MP-60/03-5	3	≤ 26 500 V	≤ 39 750 V	3	0.6 x 5	14
MP-60/03-10	3	≤ 26 500 V	≤ 39 750 V	3	0.6 x 10	28
MP-100/03-5	3	≤ 26 500 V	≤ 39 750 V	3	1 x 5	25
MP-100/03-10	3	≤ 26 500 V	≤ 39 750 V	3	1 x 10	53.5
MP-60/05-5	4	≤ 36 000 V	≤ 54 000 V	5	0.6 x 5	28
MP-60/05-10	4	≤ 36 000 V	≤ 54 000 V	5	0.6 x 10	44
MP-100/05-5	4	≤ 36 000 V	≤ 54 000 V	5	1 x 5	45
MP-100/05-10	4	≤ 36 000 V	≤ 54 000 V	5	1 x 10	89

THE

-  High quality dielectrical rubber.
-  Non-skid surface.
-  Regulatory mark clearly indicating the mat features.



INSULATING MATS HV

Those mats are out of scope of IEC 61111 (maximum class 4/36 kV). Manufacturing process and material are strictly similar to mats compliant to IEC 61111

Reference	Umax. kV	Thickness mm	 m	
MP-100/10-5	90	10	1 x 5 m	87
MP-100/10-10	90	10	1 x 10 m	154

Contact us for any particular application

THE

-  High quality dielectrical rubber.
-  Non-skid surface.
-  Regulatory mark clearly indicating the mat features.

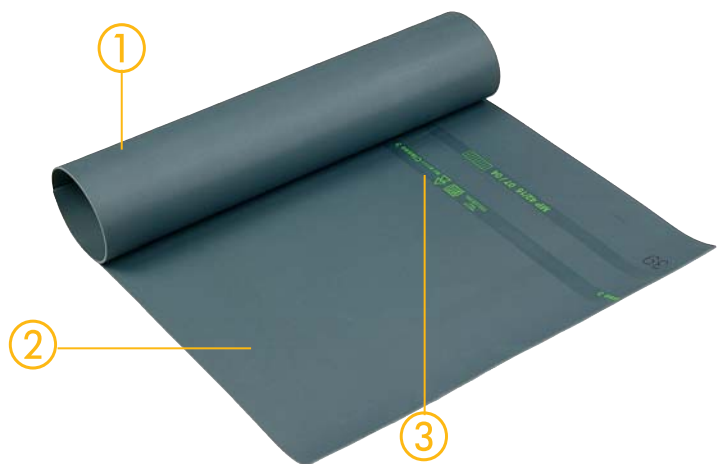

BAGS FOR INSULATING MATS

Specially designed for carrying and protecting insulating mats
Equipped with a shoulder strap.

Reference	Characteristics	Length	g
MP-01	For MP-11/16, MP-42/16, MP-42/66 and MP-60/05-1	0.7 m	0.45
MP-02	For MP-11/11, MP-42/11 and MP-100/05-1	1.1 m	0.70

THE +

- 1 Plastic window for instructions and storage identification.
- 2 Highly resistant bag with lateral zip-closed pockets and identification window.



MULTI-POCKETS ELECTRICIAN BAGS

Specially designed for carrying and protecting insulating mats, face shield and controllers.

Reference	Dimensions (mm)	g
M-87386	650 x 150 x 250	850
M-87387	690 x 300 x 140	470

THE +

- 1 Highly resistant bag with lateral zip-closed pockets and identification window.
- 2 800 denier dust resistant nylon with PVC coating.
- 3 Lockable.



INSULATING PLATFORMS (INDOOR MODELS)

Reference	Class	Rated insulation	Standards	Height mm	kg
CT-7-25/1	4	≤ 36 kV	UNE 204 001	220	3.7
CT-7-40/1	5	≤ 45 kV	UNE 204 001	260	3.9

THE +

- 1 Moulded insulating material, one-piece.
- 2 Top 50 x 50 cm.





INSULATING PLATFORMS (INDOOR MODEL)

Reference	Rated insulation	Height mm	kg
CT-7-63	≤ 63 kV	515	3.35

THE +

- 1 Removable feet with rubber tips.
- 2 Solid plate with moulded insulating material 52 x 52 cm, thickness 40 mm.



INSULATING PLATFORM (OUTDOOR MODELS)

Reference	Rated insulation	Height mm	kg
CT-9-25	≤ 24 kV	350	6
CT-9-45	≤ 45 kV	435	6.5
CT-9-63	≤ 63 kV	515	7

THE +

- 1 Solid plate with moulded insulating material 52 x 52 cm, thickness 40 mm.
- 2 Insulating skirts.
- 3 Feet with rubber tips.



Arc Flash Protection the solution for complete electric arc protection



THE "ARC FLASH" PHENOMENON.

An electric arc follows a short circuit. It produces nearly instant effects with serious consequences without proper protection.

- The arc's main manifestation is its thermal effect. The heat energy released, which is proportional to the voltage, intensity, and fault length, can be considerable (19.000°C), melting the metal and charring the insulation.
- Blast effect, caused by the very rapid release of energy in a limited volume of air (similar to an explosion).
- Light effect with high ultraviolet and infrared radiation.
- Ionisation effect that can trigger an arc on nearby active sections.

When electric arc danger exists, heat-resistant clothing must be worn. The arc's characteristics are given by:

- **The resistance value of the free arc, expressed in cal/cm² according to NFPA 70 E, ASTM standards, and IEC 61482-1-1.**
- or
- **The protection class (1 or 2) with a constrained arc according to IEC 61482-1-2**

PROTECTION AGAINST ARC FLASH

The following are used to determine the proper equipment for protecting against an electric arc:

- The maximum fault current value.
- The phase/ground rated voltage at the site of the risk.
- The distance between the source of the arc and the reception surface.
- The AC cycle number and the mono or three-phase circuit type.
- The location where the arc is produced (confined space).

After recording these parameters, we can estimate the level of risk and determine the proper protective clothing and PPE to use: **12 to 100 cal/cm²** or class **1 or 2**. For more information, please contact our technical department.



Fire-retardant clothing in case of exposure to an electric arc, conforming to IEC 61482-2 and the regulation NFPA 70E.





INSULATING GLOVES FOR "ARC FLASH" PROTECTION PAGE 26

IEC 61482-1-1 /CLASS2 ASTM
F2675/F2675 M
ATPV : 12 CAL/CM²
EN 60903 

CE



NOMEX III® UNDERGLOVES

100% Nomex III® fire-resistant and heat-resistant undergloves.

Protects the hands against heat of up to 100°C. Ideal protection for "arc flash" equipment.

EN 407
EN 420

CE



Fire protection

1

Reference	Characteristics		
CG-37	One size	Includes 5 pairs	32

THE 

1 High performance synthetic Nomex III® fibre.

"ARC FLASH" FACE SHIELD KIT (12 CAL/CM²-CLASS 2)

Reference	KIT-ARC-01	
Composition	1.5	
MO-187	1 Face shield with chin cup 12 cal/cm ² , absorbs > 99.9% of harmful UV radiation, 60% light transmission, tested to ASTM F 2178 specifications	
MO-182/1-B	1 ABS helmet electrically insulated EN397, EN 50365, ANSI Z89.1 20KV.	
M-87413	1 carrying bag for face shield and helmet	

IEC 61482-1-2 / GS-ET-29
ASTM : F2178
EN166, EN170 protection.



THE

- 1 Electrician ABS helmet.
- 2 Large field of view.
- 3 Anti UV and polycarbonate 1.5 mm thickness.
- 4 Chin protection.

"ARC FLASH" HELMETS

The only one all integrated helmet with "arc flash" faceshield on the market. Patented by CATU.

Reference	Characteristics	
MO-180-ARC-4	Screen 4 cal/cm ² class 2 Transmission of light > 75%	0.790
MO-180-ARC-12	Screen 12 cal/cm ² class 2 Transmission of light > 60%	0.790

NFPA 70E



ASTM F2178

ATPV 4 and 12 Cal/cm²

IEC 61482-1-1 

IEC 61482-1-2 / GS-ET-29
Class 2



THE

- 1 Mechanical & Electrical Protection helmet EN 397 EN 50365 - 1 000 V / ANSI Z 89.1 - 20 kV.
- 2 IEC 61482-1-1 / IEC 61482-1-2 arc protection. UV protection and EN166, EN170 protection.
- 3 Flexible and compact fabric protection "Arc flash".
- 4 Optimal colour recognition and visibility (MO-180-ARC-4). Retractable screen and neck protection.



Retractable screen and flaps



"ARC FLASH" COVERALL DOUBLE ZIPPER

Protects against the thermal hazards of an electric arc.
Easy to put on.



NFPA 70E



IEC 61482-2

Class 1-12 cal/cm²

Reference	Characteristics	kg
MV-105-(*)	Ultra Soft® Fabric	1.4

(*) to complete by size S, M, L, XL, 2XL. Other sizes on request.

THE +

- 1 Double zipper along the entire length.

"ARC FLASH" EQUIPMENT

Reference	Characteristics
SJ-12-S	Ultra Soft® Fabric
SJ-12-M	
SJ-12-L	
SJ-12-XL	
SJ-12-2XL	



IEC 61482-2

Class 1-12 cal/cm²



THE +

- 1 Ideal for manoeuvring operations of short duration (opening/closing a breaking device)
- 2 Easy to put on and remove

PARKA "ARC FLASH"

Reference	Size
M-883374	PARKA "ARC FLASH" CLASS 2 size S
M-883377	PARKA "ARC FLASH" CLASS 2 size M
M-883378	PARKA "ARC FLASH" CLASS 2 size L
M-883379	PARKA "ARC FLASH" CLASS 2 size XL
M-883380	PARKA "ARC FLASH" CLASS 2 size 2XL
M-883381	PARKA "ARC FLASH" CLASS 2 size 3XL



IEC 61482-2

Class 2



"ARC FLASH" JACKET AND PROTECTIVE COVERALL KITS (12 CAL/CM²)

Complete ready-to-use kits, compliant with the IEC 61482-1-2 Arc Flash class 1.

Reference	Characteristics	Capacity cal/cm ²
KIT-ARC-12-C-(*)	Coverall	12 cal/cm ²
KIT-ARC-12-J-(*)	Long hooded jacket	12 cal/cm ²
KIT-ARC-12-JP-(*)	Short jacket without hood + pants	12 cal/cm ²

(* Reference to be completed by the size M, L or XL. Size S to 3 XL on request.

Composition of KITS

MO-187	1 Face shield with chin cup 12 cal/cm ² , absorbs > 99.9% of harmful UV radiation, tested to ASTM F2178 specifications	1
MO-182/1-B	1ABS helmet electrically insulated EN397, EN 50365, ANSI Z89.1, 20kv.	1
MO-11000	1 safety glasses EN 166/EN 170	2
MO-134	1 arc flash protective hood (12 cal/cm ²), only with coverall and blue short jacket.	3
-	1 protective coverall 12 cal/cm ² , ASTM F1506 and NFPA 70E Standards or 1 arc flash protective jacket 12 cal/cm ² , ASTM F1506 and NFPA 70E Standards.	4 5
M-87413	1 carrying bag for face shield and helmet.	
M-87295	1 all kit carrying bag.	6

THE +

- 1 Protective capabilities, resistant to washing cycles.
- 2 All the Arc Flash 12 cal kits are compliant with the IEC 61482-1-2 standard class 1.
- 3 Complete ready-to-use kits.



KIT-ARC-12-J

NFPA 70E



IEC 61482-2





"ARC FLASH" PROTECTIVE KITS (25, 40, 65 OR 100 CAL/CM²)

Complete ready-to-use kits, compliant with the IEC 61482-1-2 Arc Flash class 2 (KIT-ARC-25 & KIT-ARC-40).

NFPA 70E



IEC 61482-2

Reference	Capacity cal/cm ²	Color
KIT-ARC-25-B-(*)	25	KAKI
KIT-ARC-40-B-(*)	40	GREY
KIT-ARC-65-B-(*)	65	BROWN
KIT-ARC-100-B-(*)	100	BROWN

(*) Reference to be completed by the size M, L or XL. Size S to 3 XL on request.





Composition of KITS	
-	1 set of Arc Flash overalls 25, 40, 65, or 100 cal/cm ² , and tested according to the ASTM F 1506 and NFPA 70E specifications 1
MO-11000	1 safety glasses EN 166/EN 170 2
M-87295	1 all kit carrying bag 3
-	1 hood with integrated screen 25, 40, 65, or 100 cal/cm ² , and tested according to the ASTM F2178, NFPA 70E and IEC 61482-2 specifications. 4
MO-182/1-B	1 ABS helmet electrically insulated EN397, EN 50365, ANSI Z89.1 20kV. 5
-	1 Arc Flash vest 25, 40, 65, or 100 cal/cm ² , and tested according to the ASTM F 1506, NFPA 70E and IEC 61482-2 specifications. 6



THE

- 1** Protective capabilities, resistant to washing cycles.
- 2** 25 and 40 cal class 2 kits according to IEC 61482-1-2.
- 3** 4 Complete ready-to-use kits.

WORK GLOVES

Reference	Size		
CG-96-*	A = 8	115	3122
	B = 9		
	C = 10		
	D = 11		
CG-97-C	One size C = 10	115	3122

(*) Reference to be completed by the size of A, B, C or D.
 Mechanical protection class : Abrasion 3/5, Slicing : 1/5, Tearing : 2/5
 Perforation : 2/5

 3122

EN 388
 EN 420
 CE



 3122



THE +

- 1 American style gloves with very soft and flexible full bloom leather allowing full finger movement.
- 2 Tightening elastic on the back of the hand.
- 3 "Docker" style gloves with very soft full bloom leather allowing full finger movement.
- 4 Semirigid red fabric top with elastic on the back.



CUT-RESISTANT GLOVES

Reference	Size (*)	
CG-951-(**)	7 to 10	4121
CG-952-(**)	7 to 10	4544

(*) Reference to be completed by the size of 07, 08, 09 or 10.

 4121

EN 388
 EN 420
 CE



 4544



THE +

- 1 Knitted glove, 15 gauge, made of texturized polyamide, black colour, black nitrilfoam coating on palm and fingertips.
- 2 Knitted glove, 13 gauge, made of cut resistant fibers, elasticated knitwrist, grey, with a black nonslip nitrilfoam coating on palm and fingertips.





ELECTRICIAN COVERALL

Coverall without metallic part, avoiding any flash hazards.
100% cotton.

Reference	Size for Ref. (*)	Size	Chest size
MV-104/ (*)	01	40/42	85/92
	02	44/46	92/100
	03	48/50	101/108
	04	52/54	109/116
	05	56/59	117/124
	06	60/62	125/132
	07	64/66	133/140

(*) Reference to be completed by the size, ex : MV-104/02.

THE +

- 1 Gusset back.
- 2 Neck jumper.
- 3 2 flattened breasts pockets closed by injected zips every plastic part hidden.
- 4 Front closed by injected zip every plastic part hidden.
- 5 Tape measure pocket on right back leg.
- 6 2 flattened thigh pockets.
- 7 Tape measure pocket on right back leg.



SAFETY SHOES

MV-123 : Low, derby style shoe without metal parts.

MV-124 : Heavy duty boots without metal parts.

Reference	Size	Marking	kg
MV-123- (*)	39 to 48	S3	1.2
MV-124- (*)	39 to 48	S3	1.26

(*) Reference to be completed by the size: 39, 40, 41, 42, 43, 44, 45, 46, 47, 48. Example: MV-123-40.

THE +

- 1 Form-fitting, antistatic HI-CI and anti-bacterial.
- 2 Bodkin strap closure.
- 3 Extreme 4 multidensity PU/TPU foam sole and puncture-resistant composite Flex System®.
- 4 Indestructible lightweight TPU end pieces, extra wide 200 joules. in Light-System® composite.



EN 20345

MV-123

COLD PROTECTION KIT AND CAP

Kit to protect against harsh weather conditions, including:

- 1 acrylic helmet cap. Protects against cold inside the helmet.
- 1 yellow high-visibility neck warmer.

Reference	Characteristics	 g
MO-158	Universal cap	55
	Neck warmer	86







THE

- 1 Universal hood.
- 2 Water-resistant neck warmer.



CATU™ Test laboratory







for all your mechanical and electrical tests



COFRAC : French Accreditation of Certification

Certificata no. 1-0897
Available at
www.cofrac.fr



ISO 9001 - ILO-OSH 2001
OHSAS 18001 - ISO 14001



Work at height, a regulation in line with the European Directive.

REGULATORY PERSPECTIVE.

The safety equipment for working at height and their methods of use are defined by the decrees:

No. 92-766 dated 29 July 1992: which applies the 1989 European Directive, No. 2004-924 dated 1st September 2004: "decree relating to the use of work equipment made available for temporary work at height".

The following are defined in these decrees:

The priority is the installation of collective protective equipment. When this is not possible, the use of a device to an item of personal protective equipment against falls from a height is required, whether this is for the purposes of retaining, support, saving, or protecting against falls from a height.

Removal of the minimum height of 3 m: After a risk evaluation, protective equipment is required as soon as there is a risk of a falling.

- The use of access and positioning techniques by means of ropes must comply with the following: a working rope, a safety rope fitted with a fall arrestor system, with two separate anchoring points. Workers must be provided with suitable fall arrestor harnesses connected to both ropes. Safe descent/mounting systems with a self-locking system and a mobile fall prevention system must be provided.
- The work must be programmed and supervised so that assistance can be given immediately to the worker in the event of an emergency.

The workers must receive suitable and specific training in the operations considered and in the rescue procedures.

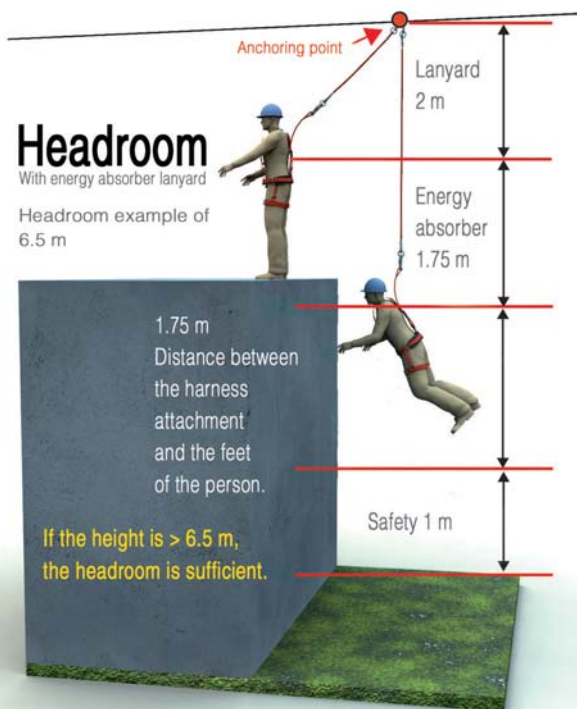

KEY PRODUCT STANDARDS

- EN 353-1Fall arrest grab for rigid support.
- EN 353-2Fall arrest grab for flexible support.
- EN 354Restraint lanyard.
- EN 355Shock absorber lanyard.
- EN 358Work positioning systems
- EN 360Retractable type fall arrestors.
- EN 361Fall arrest harness.
- EN 362Connectors.
- EN 363Fall arrest systems.
- EN 813Sit harnesses.

Scan this QR Code to download our Safety Guide



To determine your harness size, see the table on 201.

BASIC BODY HARNESS

Universal size, adjustable by rectangular buckles.

Reference	Size	kg
MO-70	Universal	0.6

THE +

- 1 2 fall arrest attachment point: dorsal and sternal,
- 2 Braided polyester straps width 20 mm.

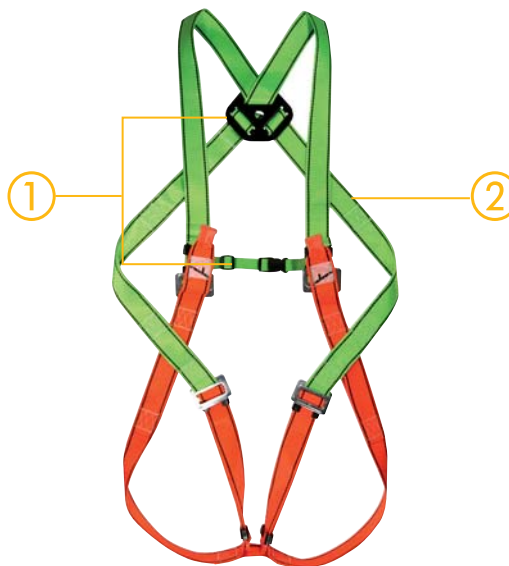

EN 361
CE



INSULATING HARNESS

- Universal size. Adjustable by rectangular buckles.
- Includes support belt sewn in harness.

Reference	Size	kg
MO-74-ISO	Universal	1.9

THE +

- 1 Completely insulated.
- 2 2 fall arrest attachment point: dorsal and sternal.
- 3 Polyester straps 45 mm large.
- 4 2 insulated and articulated rings on the belt for attachment of the maintaining at work lanyard.
- 5 Wide belt maintenance and semi-rigid.
- 6 Dielectric strength for all the insulated parts: 27.2 kV/mm.



EN 361
CE



ATEX HARNESS

- Universal size. Adjustable by rectangular buckles.
To work in ATEX atmosphere:
- Zones 1 and 2 for gas and vapours
- Zones 21 and 22 for dust

Reference	Size	kg
MO-72-ATEX	Universal	0.8

THE +

- 1 Mat reinforcement on the back, shoulders and thighs.
- 2 1 fall arrest dorsal anchor point
- 3 1 fall arrest chest anchor point : composed of 2 D-rings to use together.
- 4 Polyester straps 47 mm large.
- 5 Thigh straps reinforced with automatic buckles.



EN 361
CE





PRO ELECTRIC FULL BODY FALL ARREST HARNESS

Fall arrester and securing harness. Optimal comfort.
Suitable for working in suspended positions.
Recommended for female staff members.

Reference	Size	kg
MO-565-(*)	S	3
	M	
	XL	

(*) Reference to be completed by the size (example : MO-565-M).
Delivered in cloth bag.

THE ⊕

- ① Dorsal and sternal anchor points through a metal ring.
- ② Ventral snap-hook.
- ③ Adjustable shoulder straps elastic stray.
- ④ 2 attachment points for maintaining at work arrest.
- ⑤ Loops "clip" automatic on short strap.
- ⑥ Wide and padded back-rest.
- ⑦ Work positioning belt.
- ⑧ Tools holders.
- ⑨ Reinforced and adjustable leg straps.



EN 358
EN 361
EN 813



PRO ELECTRIC FULL BODY FALL ARREST HARNESS

Particularly suitable for working with aerial networks.

Reference	Size	kg
MO-563-A(*)	S	2.7
	M	
	XL	

(*) Reference to be completed by the size (example : MO-563-A-M).
Delivered in cloth bag.

THE ⊕

- ① 180° rotation of the positioning belt.
- ② Dorsal anchor point on short strap.
- ③ Sternal anchor point on 2 butterfly harness straps, to be used together.
- ④ Adjustable shoulder straps elastic stray.
- ⑤ Automatic "clip" loops on the leg straps and belt.
- ⑥ 2 attachment points for maintaining at work.
- ⑦ Reinforced and adjustable leg straps
- ⑧ Tools holders.
- ⑨ Back-rest with storage place for the periodic maintenance sheet.



EN 358
EN 361



FULL BODY FALL ARREST HARNESS

Reference	Size	kg
MO-71	One size	1.9

Delivered in a canvas bag.

THE +

- 1 Attachment point: dorsal and sternal
- 2 2 buckles of work positioning.
- 3 Work positioning belt.
- 4 Adjustable straps.
- 5 Back-rest.



EN 358
EN 361
CE



KIT FOR RESTRAINT AT WORK

Equipment that prevents the operator from going to a place from where he or she may fall.

Composition	Reference: KIT-HAUT-10
MO-70	1 fall arrester harness with 2 anchoring points.
-	1 retaining lanyard, 1.5 m long
-	2 screw hooks

THE +

- 1 A simple, light and practical fall arrester solution.
- 2 Suitable for working in flying scaffolds or on platforms.



MO-70

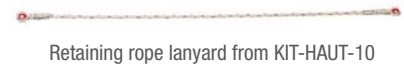

Retaining rope lanyard from KIT-HAUT-10



Snap hooks from KIT-HAUT-10

FALL ARREST BASIC KIT

Equipment suitable for working in flying scaffolds or on platforms.

Composition	Reference: KIT-HAUT-06
MO-71	Full body fall arrest harness
MO-52020	Adjustable lanyard equipped with 2 steel snap hooks with automatic locking, Length : 1.50 m.
M-87295	1 carrying bag

THE +

- 1 Harness fitted with a positioning belt with anchor loops.
- 2 Single lanyard with shock absorption.



MO-71



MO-52020



M-87295



FALL PROTECTION KIT FOR WORKING AT HEIGHTS ABOVE 6 M

Fall protection kit for operators working at a height of more than 6 m.

Composition	Reference: KIT-HAUT-11
MO-70	1 fall protection harness with 2 anchor points
MO-52040	1 extensible lanyard with 2 m length with shock absorber and connector with automatic lock opening 54 mm



MO-70



MO-52040

THE +

- 1 Suitable for many applications over 6 m height.
- 2 Simple, light, practical.

FALL PROTECTION KIT FOR WORKING AT LOW HEIGHT

Equipment for operator working at heights between 3 and 6 m.

Composition	Reference: KIT-HAUT-12
MO-70	1 fall protection harness with 2 anchor points
MO-591001	1 automatic fall protection device with a strap of 2.5 m length and shock absorber
MO-52031	1 anchor tie of length 1 m

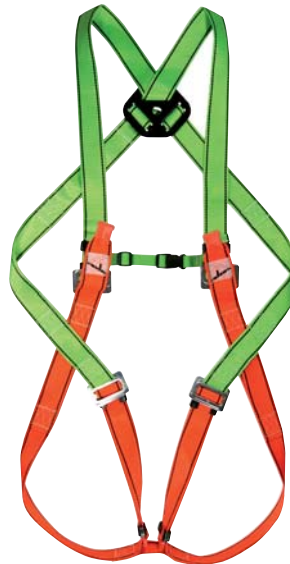

MO-70



MO-591001



MO-52031

THE +

- 1 The automatic brake system stops the fall within a few centimetres.
- 2 Simple, light, practical.

FALL PROTECTION KIT FOR WORKING ON ROOF

Equipment suitable for working on roofs or on sloped planes.

Composition	Reference: KIT-HAUT-13
MO-70	1 fall protection harness with 2 anchor points
MO-69/10	1 mobile fall protection on rope length of 10 m
-	2 snap hooks
MO-52031	1 anchor tie of length 1 m

THE +

- 1 The mobile fall protection is adapted for sloped roof.



FALL ARREST KIT WORKING ON PYLON

Equipment suitable for working on all types of pylons, metal structures, antenna supports or metal poles.

Composition	Reference: KIT-HAUT-05
MO-71	1 pro single fall protection harness with 2 anchor points
MO-54010	1 double fall protection lanyard with shock absorber, length 1.2 m
MO-56009	1 support lanyard with tensioner, length 2 m
M-87295	1 carrying bag

THE +

- 1 Harness with support belt.





KIT FOR WORKING ON LV INSULATING LADDER

Equipment suitable for work on pole or facade with standard insulating ladder.

Composition	Reference: KIT-HAUT-01-(*)
MO-563-A	1 pro electrician fall protection harness with 2 anchoring points and 180° rotating support belt for work
MO-68/15	1 mobile fall protection on rope length of 15 m
MO-52020	1 single fall protection with shock absorber, length 1.5 m
MO-56009	1 support lanyard with tensioner, length 2 m
MO-54	1 snap hook
MO-52034	1 anchor tie of 1.5 m length
M-87295	1 carrying bag

(*) Reference to be completed by size M or XL



MO-563



MO-52020



MO-68/15



MO-56009



MO-52034



M-87295



MO-54

THE +

- 1 Kit offering the necessary functions and comfort of use.
- 2 Kit adapted with the constraints of electrical works at height.

KIT FOR WORKING ON POLE WITH MOVABLE LADDER

Equipment suitable for working on movable ladders to be fixed on pole.

Composition	Reference: KIT-HAUT-02-(*)
MO-563-A	1 pro electrician fall protection harness with 2 anchoring points and support belt for work
MO-68/15	1 mobile fall protection on rope length of 15 m
MO-54010	1 double fall protection lanyard with shock absorber, length 1.2 m
MO-56009	1 support lanyard with tensioner, length 2 m
MO-54	1 snap hook
MO-52034	1 anchor tie of 1.5 m length
M-87295	1 carrying bag

(*) Reference to be completed by size M or XL



MO-563



MO-54010



MO-68/15



MO-56009



MO-52034



M-87295



MO-54

THE +

- 1 Kit adapted with the live line working requirements on the aerial LV and MV networks.
- 2 The harness support belt can be rotated up to 180°.

KIT FOR WORKING ON SUPPORTS OF CATENARIES

Equipment suitable for work on pylons or pole supporting catenaries.

Composition	Reference: KIT-HAUT-03-(*)
MO-563-A	1 pro electrician fall protection harness with 2 anchoring points and support belt for work
MO-68/15	1 mobile fall protection on rope length of 15 m
MO-54020	1 double insulated fall protection lanyard with shock absorber, length of 1.5 m
MO-56009	1 support lanyard with tensioner, length 2 m
M-87295	1 carrying bag

(*) Reference to be completed by size M or XL

THE +

- 1 Kit adapted for the requirements of railway overhead networks.
- 2 The harness support belt can be rotated up to 180°.



KIT FOR WORKING ON PYLONS AND METALLIC STRUCTURES

Equipment suitable for working on all types of pylons, metal structures, antenna supports or metal poles.

Composition	Reference: KIT-HAUT-04-(*)
MO-565	1 pro electrician fall protection harness with 2 anchoring points and 1 ventral attachment point and work support belt
MO-68/15	1 mobile fall protection on rope length of 15 m
MO-54010	1 double fall protection lanyard with shock absorber, length 1.2 m
MO-56009	1 support lanyard with tensioner, length 2 m
MO-52031	1 anchor tie of 0.8 m length
M-87295	1 carrying bag

(*) Reference to be completed by size M or XL

THE +

- 1 Kit adapted to the requirements of the aerial networks on all types of pylons.
- 2 Optimal comfort harness.

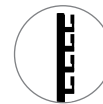



TOOL BAG FOR SAFETY HARNESS

2 pocket leather pouch.
Seam and rivet assembly.

Reference	 mm	 kg
MO-32/3	270 x 230 x 100	0.835





ANTI-FALL GRIP

“ROP CHUCK” FALL ARREST. Uses special Ø 15 mm rope exclusively with a spliced upper end. To be used with a harness.

EN 353-2



Reference	Semi-static rope		 kg
		 mm	
MO-68/10	10 m	15	4
MO-68/15	15 m	15	6

Delivered complete only.

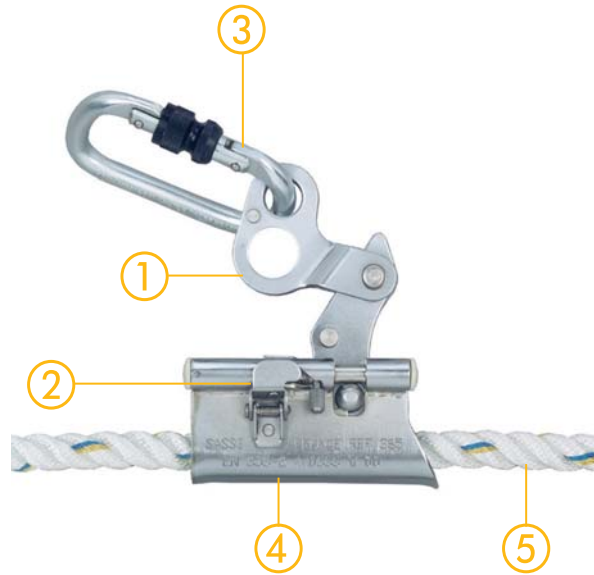

THE +



- 1 Work from the bottom to top without the operator's manual intervention.
- 2 Fall Arrest Falls are instantly blocked with the lifeline. It remains locked until it is unlocked.
- 3 Anchor connector to harness.
- 4 Double lock bracket.
- 5 Rope.

FALL ARRESTER ON ROPE

To be used with harness and security rope Ø 11 mm.

N 353-2



Reference	Semi-static rope		Static resistance	 kg
		 mm		
MO-69/10	10 m	11	≥ 15 kN	4
MO-69/15	15 m	11	≥ 15 kN	6
MO-69/20	20 m	11	≥ 15 kN	8



THE +

- 1 Suitable for working on inclined planes.
- 2 Fall protection device for rope with automatic locking system.
- 3 Support the rise/ascent without manual intervention. Must be supported on descent.
- 4 Semi-static rope.

ANTI-FALL DEVICE WITH AUTOMATIC RELEASE STRAP

Reference	Anti-fall	Static resistance	
MO-591000	2 m	≥ 15 kN	1.16

THE

- 1 Fall protection: automatic locking retractable strap, equipped with a shock absorber.
- 2 Snap hook anchor with harness.

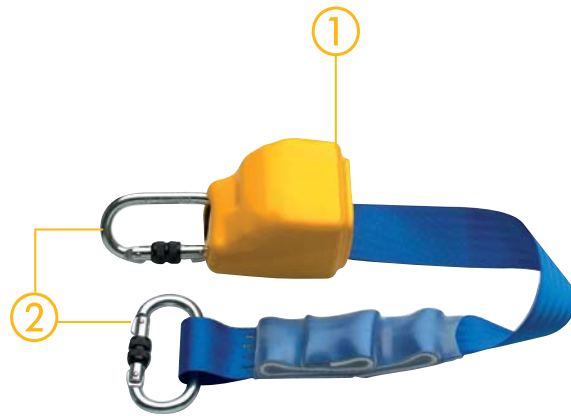

EN 360
CE



FALL ARRESTER RETRACTABLE TYPE

Reference	Cable	Static resistance	
MO-591002	10 m	≥ 12 kN	5
MO-592002	20 m	≥ 12 kN	7

THE

- 1 Integrated braking mechanism and dissipating element. Self locking mechanism and automatic tensioning and return facility.
- 2 Snap hook.



EN 360
CE



ANTI-TRAUMA SECURITY STRAPS

The straps are equipped with loops for the feet allowing the operator to stand straight. This relieves the pressure on the arteries that surround the upper legs. The two straps can be bonded together by a quick coupling. Product composed of a pair of straps. Each strap is folded in a fabric case.

Each strap, in its case, attaches directly to the harness. The compact and lightweight product has no discomfort while working with harness.

Quick and easy installation of the device after the fall operator.

Reference		
S0-10	maxi: 1.3 m	0.2





EQUIPPED ROPE STRAPS WITH LEVER STRETCHER

Anchorage with the support belt by quick link.
For maintenance work function.

Reference	Characteristics	kg
MO-52-L*	Length: 4 m	1
MO-61	Stretcher only	0.450

Lanyard Protector

* Equipped with adjuster

Reference	Characteristics	↔
MO-52-P	Chrome leather sleeve	95 cm



EN 358
CE

TETHER ROPE EQUIPPED WITH A TENSION DEVICE

Ideal for all horizontal works, and maintaining at work.

Reference	↔	∅ mm	kg
MO-56009	2 m	12	0.750
MO-56010	5 m	12	1

THE ⊕

- 1 Tensioning device: A double-locking system instantly stops the rope.
- 2 Polyamid rope.
- 3 Connector made of light alloy with double safety.

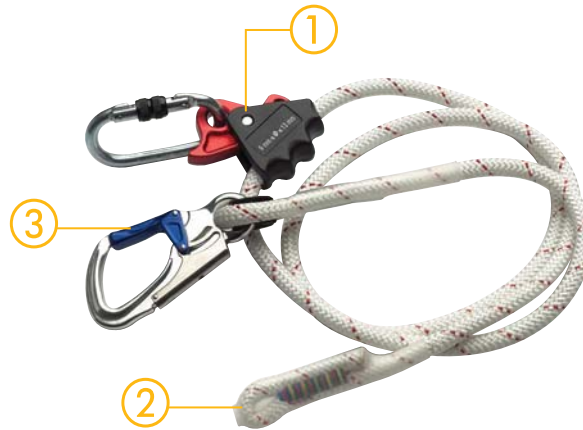

EN 358
CE

DOUBLE TETHER ROPE WITH ENERGY ABSORBER

Fall protection function.

Reference	↔	↔ after rupture	F	kg
MO-52020	Length: 1.5 m	3 m	≥ 22 kN	1.1
MO-52021	Length: 2 m	3.5 m	≥ 22 kN	1.2

THE ⊕

- 1 Equipped with 2 steel snap hooks with automatic locking.
- 2 Strap adjuster.
- 3 1 steel snap hook with screwing locking.
- 4 Tether rope with energy absorber. ∅ 14 mm.



EN 355
CE

STRETCHABLE SHOCK-ABSORBING LANYARD

Fall protection function.

Reference	Strap		F	kg
	Rest	Stretch		
MO-52040	1.25 m	1.75 m	≥ 22 kN	0.7

THE +

- 1 Strap adjuster.
- 2 Connector, with automatic locking system, opening: 19 mm. For harness connection.
- 3 Connector, with automatic locking system, opening: 54 mm.

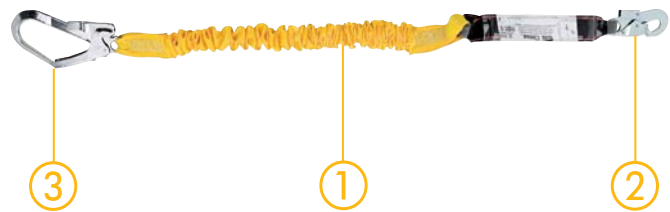

EN 355
CE



INSULATING ENERGY ABSORBING FORKED LANYARD WITH BUCKLES

Fall protection function. Two locking connectors Automatic, opening 54 mm.

Reference	↔	F	kg
MO-54020	1.5 m of straps	≥ 22 kN	1.5

THE +

- 1 Fully insulating.
- 2 Isolated connectors with automatic locking. Opening 54 mm.
- 3 Double insulated lanyard with buckles for anchors. Multiple on each strap.

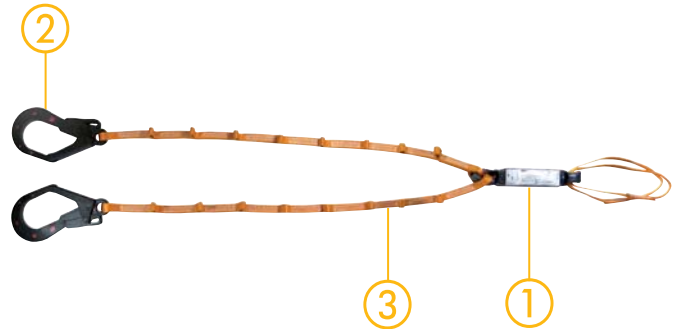

EN 355
CE



FORKED LANYARD WITH ENERGY ABSORBER

Fall protection function.

Reference	↔	↔ after rupture	F	kg
MO-54010	1.2 m of straps	3 m	≥ 22 kN	1.4

THE +

- 1 Equipped with 2 steel snap hooks with automatic locking.
- 2 1 steel snap hook with screwing locking.
- 3 Double tether rope with energy absorber.

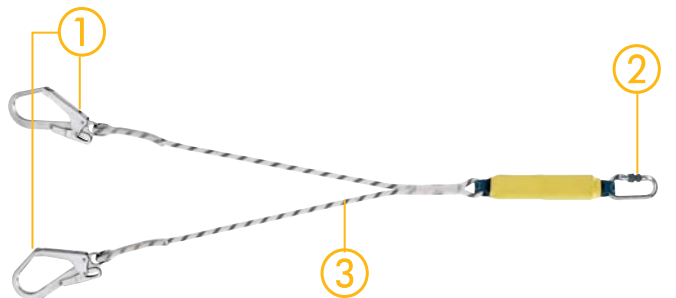

EN 355
CE



F Resistance

mm Dimensions Weight ↔ Total length Diameter



FORKED STRETCHABLE SHOCK-ABSORBING LANYARD

EN 355
CE

Fall protection function. For connection to structures.

Reference	Strap		F	kg
	Rest	Stretch		
MO-54040	1.25 m	1.75 m	≥ 22 kN	1.5

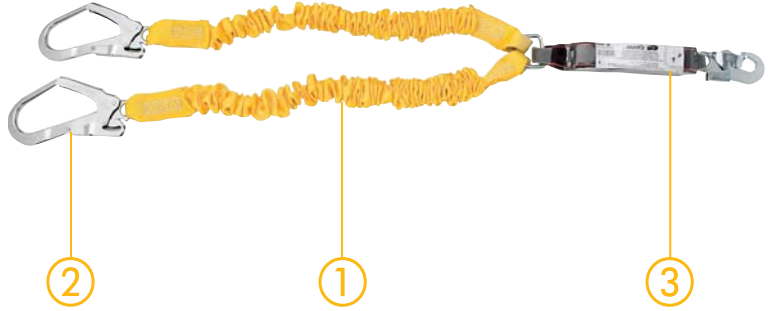

THE ⊕

- ① Stretchy straps.
- ② Expandable connectors with automatic locking, Opening 54 mm.
- ③ One connector with automatic locking. Opening 19 mm. For connection on harness.

DOUBLE LANYARD

EN 358
CE

Can be connected to the harness by locking steel screw karabiners.

Reference	↔	∅ mm	kg
MO-53010	2 x 1 m	12	1.4



THE ⊕

- ① Double-latch karabiner, 54mm opening.
- ② Two-strand nylon lanyard

MOBILE SAFETY LINE

EN 795
CE

Easy and quick to set up, this line can be used by 2 people. It is equipped with a tension device. This safety line is designed for short operations. The users can then hook themselves to the safety line using a fall arrest device or a shock absorbing lanyard. When using a shock absorbing lanyard, allow for at least 7 meters clearance.

Reference	↔	F	kg
MO-53002	5 to 20 m	10 kN at each anchor point	2.8

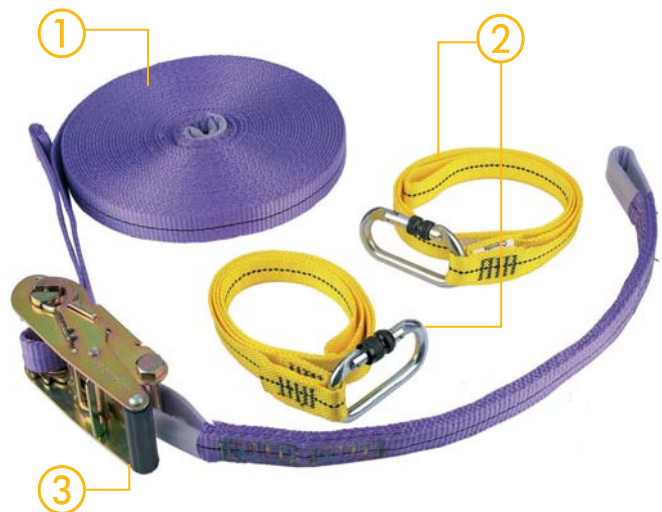

THE ⊕

- ① Flexible implementation.
- ② Anchor ties with connectors.
- ③ Adjustable strap tensioner.

SAFETY ROPE WITH WEAR TELL TALES

Two-colour safety rope, 100% polyester made of 3 white strands with black central thread.

Reference	↔	∅ mm	F	kg
MO-052	4 m	15	≥ 22 kN.	0.8

THE +

- 1 Static rope with wear indicator.
- 2 Buckle with plastic reinforcement.



EN 354
CE



EN 354
CE

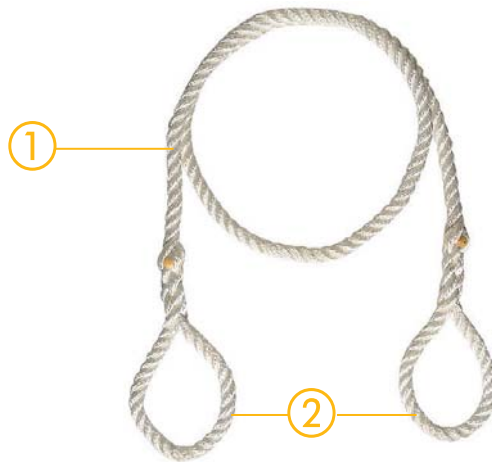

LANYARD

Reference	↔	∅ mm	F	kg
MO-53	1.5 m	10	≥ 22 kN	0.2

THE +

- 1 Synthetic fibre ropes.
- 2 Loops spliced at both ends.



DOUBLE SAFETY DESCENT DEVICE

Double safety manual descent device. Works on a static 11mm lanyard. Its ergonomic shape improves the self-adjusting descent.

Reference	∅ Lanyard mm	kg
MD-02	11	0.4

THE +

- 1 Stainless steel piece.
- 2 High-resistance handle. Anti-panic and anti-faint (auto-locking).



EN 341-A
CE



F Resistance

mm Dimensions

Weight

↔ Total length

∅ Diameter



ASCENSION BLOCKER

Blocking handle allows the operator to climb along a rope.

Reference	Characteristics	
MD-03	For ropes of Ø 8 to 13 mm.	0.2

THE

-  Light alloy.
-  Blocking of the rope by retractable trigger.





EN 567
CE

SNAP HOOKS

Reference				
MO-54	18	20 kN	100 x 58 mm	154
MO-55/1	28	20 kN	155 x 75 mm	140
MO-54000	19	20 kN	100 x 58 mm	78
MO-54004	23	20 kN	120 x 72 mm	87

THE

-  Locks with threaded ring.
-  Additional catch is provided to prevent the rope from slipping in the carabiner.
-  D-shaped snap hook with automatic locking.

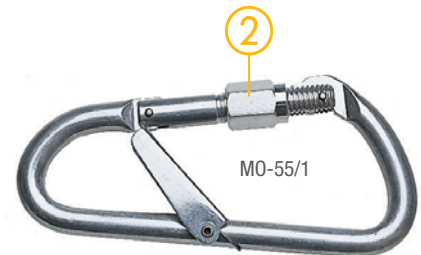

EN 362
CE

SEMI-ROUND QUICK LINK

For long-term or permanent fixing point.

Reference	\vec{F} Large axis	\vec{F} minor axis*	kg
MO-54-D	25 kN	10 kN	75

*Clasp closed.

THE \oplus

- ① Opening 10 mm.
- ② Semi-round ring \varnothing 8 mm mini. Made of steel treated against corrosion.

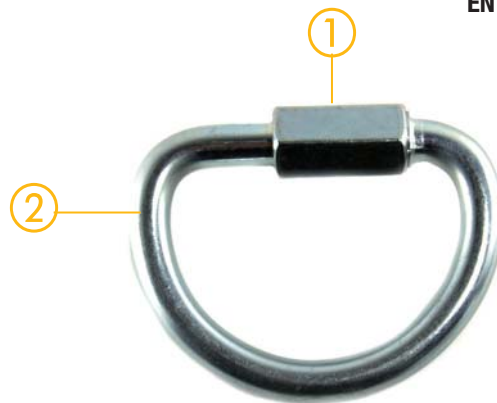

EN 362 - Class Q

CE



SAFETY CONNECTORS WITH DOUBLE LATCH

To be fixed at the end of the lanyard.

Reference	mm	\vec{F}	kg
MO-54002	50 mm	20 kN	0.4
MO-54002/1	60 mm	20 kN	0.25
MO-54002/2	100 mm	20 kN	0.53

THE \oplus

- ① Made of aluminium alloy except MO-54002.
- ② Automatic double latch lock.

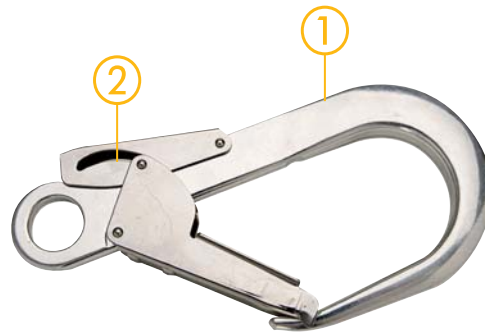

EN 362 - Class A

CE



ANCHORAGE HOOK

Hook for frequent connections on tubular structures.

Reference	mm	\vec{F}	kg
MO-54005	100 mm	20 kN	0.35

THE \oplus

- ① Stainless steel wire \varnothing 6 mm.
- ② Large opening by manual pressure.

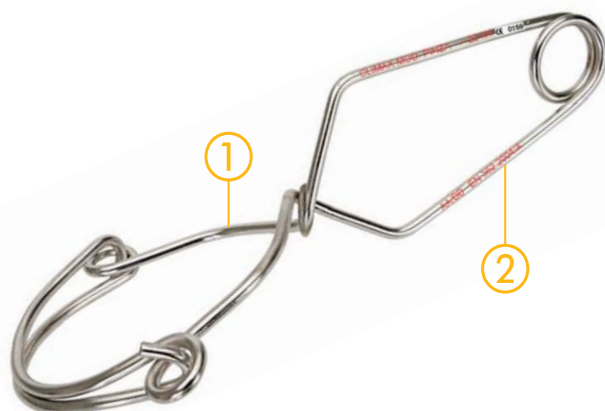

EN 362 - Class A

CE





SNAP HOOK WITH STICK ADAPTOR

To fix a life line from the ground. Snap hook to be operated with a stick and unlocking using a cord.

Connector with stick adaptor

Reference	mm	Type	kg
MO-54005-C	110	C End fitting	0.47
MO-54005-K	110	K End fitting	0.47

Telescopic stick

Reference	Deployed Length m	Folded length m	kg
CE-5-105-X	10.75	1.66	5.4
CE-5-90-X	9.25	1.61	4.2
CE-5-70-X	7.8	1.56	3.3
CE-5-60-X	6.4	1.51	2.5
CE-5-50-X	5	1.46	1.9

X: Tip type to be specified when ordering.
(K: universal, C: hexagonal)

THE +

- 1 Allows to lay a lifeline remotely.
- 2 Connector equipped with adaptor for pole.
- 3 Telescopic pole up to length of 10.75 m.
- 4 Diam. 25 for fixing lifeline.

EN 362

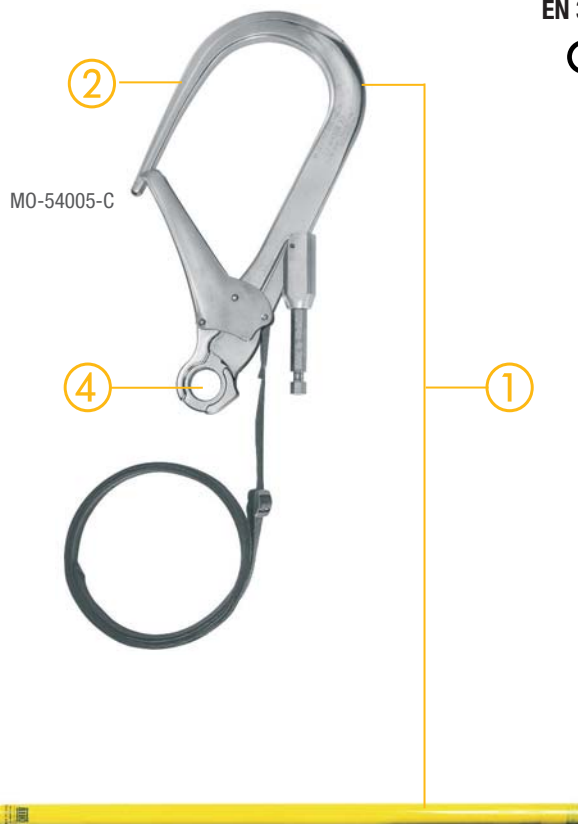

CONSTRAINT TIE

Reference	↔	\vec{F}_{Max}	kg
MO-52031	0.8 m	20 kN	100
MO-52033	1.20 m	20 kN	135
MO-52034	1.50 m	20 kN	150

Mobile

Mobile anchor point designed to work on wood or concrete pole..

Reference	↔	\vec{F}_{Nm}	kg
MO-52030-P	1.50 m	15 kN	0.5

THE +

- 1 Used as fall protector during the 1st climb on Wood / concrete pole.
- 2 Anchor buckle with the harness.
- 3 90 mm wide polyester strap with reinforcement.

EN 795



CLIMBERS

Mechanical climbers for round and hexagonal concrete poles

Reference	∅ Pole mm	kg
MO-16-A	140 > 300	6.5

Delivered by pair.

Forged steel climbers for round wooden poles

Reference	∅ Pole mm	kg
MO-24	200	2.6
MO-25	250	2.8
MO-26	300	3
MO-35	350	3.2

Delivered by pair.

Climbers for steel beams

Shayed IPN, H ou L.

Reference	mm	kg
MO-23	5 to 20	5.1

Delivered by pair.

THE +

- 1 Adaptable to the pole diameter.
- 2 Leather belts with cast buckles.
- 3 Hard forged steel.

MECHANICAL CLIMBERS FOR RECTANGULAR SHAPED CONCRETE POLES

For rectangular shaped concrete poles.

Reference	Pole width	kg
MO-17-A	14 to 42 cm	9

Delivered by pair.

THE +

- 1 Automatic locking of jaws by elastic cord.
- 2 Sole in aluminium alloy, high resistance, with leather belts and steel buckle.
- 3 High resistance aluminium alloy rack, used for clamping onto poles 14 to 42 cm wide.
- 4 Mobile drum on axis can be removed; processed steel rollers.
- 5 Wear plate placed on sole arm.

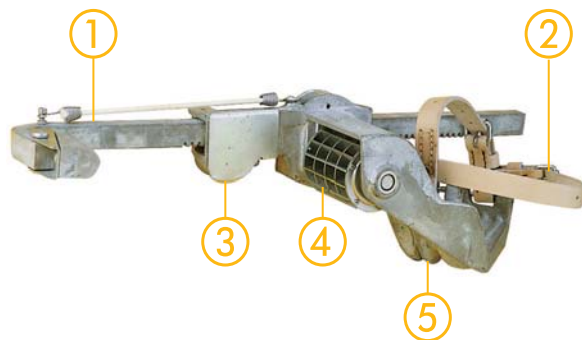
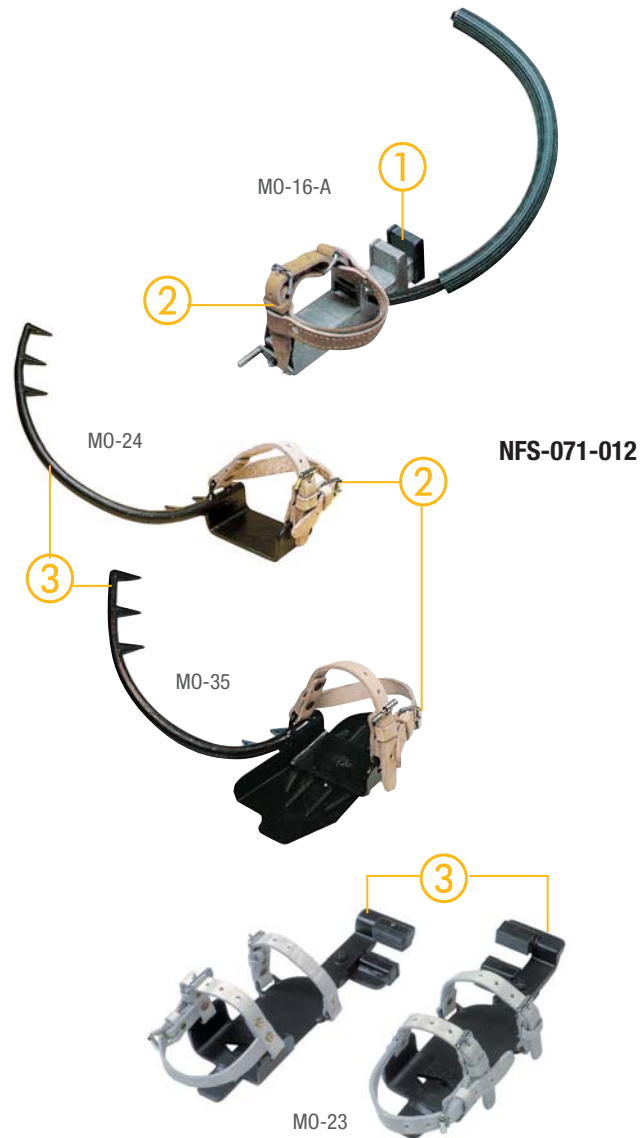

Spare parts

Reference	Characteristics
MO-17-01	Pair of elastic cords
MO-17-02	Pair of wear plates
MO-17-03	Blade roller
MO-17-04	Pair of runners





SECURITY INSULATING LADDERS

Work on or near electrical works and electrical installations maximum voltage of 1000 V AC or 1500 V DC.
 Minutes N° NF 930-03/01/01-29 L.N.E / AFNOR showing compliance with EN-131 and the mark "NF" (Quality Label).

A complete range to high specifications:

- Nominal insulation between 2 bars after immersion in water: 10 000 V (EN 50528).
- High mechanical resistance to bending and torsion.
- Good strength / mass.
- Marking of information for use.
- High resistance to weather and corrosive elements and fire.
- The maximum working load 150 daN.



INSULATING LADDERS

Comes with right horizontal stabilizer.

Simple ladders

Reference	↔	Numbers of rungs	kg
MP-602-D	2.41 m	8	6
MP-603-D	2.97 m	10	9
MP-604-D	4.09 m	14	10
MP-605-D	4.93 m	17	12

2 sections extension ladders

Reference	↔ Folded	↔ Extended	Numbers of rungs	kg
MP-620-D	-	1.02 m	2 x 4	5.6
MP-624/2-D	2.41 m	4.09 m	2 x 8	14.9
MP-634/2-D	2.70 m	4.65 m	2 x 9	17

Optional accessories:

Cradle support post and front Wheel MP-46503.

THE ⊕

- 1 For working live LV.
- 2 Lateral risers in polyester/ glass fiber rectangular section 70 x 25 mm. Aluminium alloy rungs with square.
- 3 29 x 29 mm section and anti-slip coating.

⚠
 NF EN 131-1
 NF EN 131-2
 NF EN 131-3
 NF EN 50528

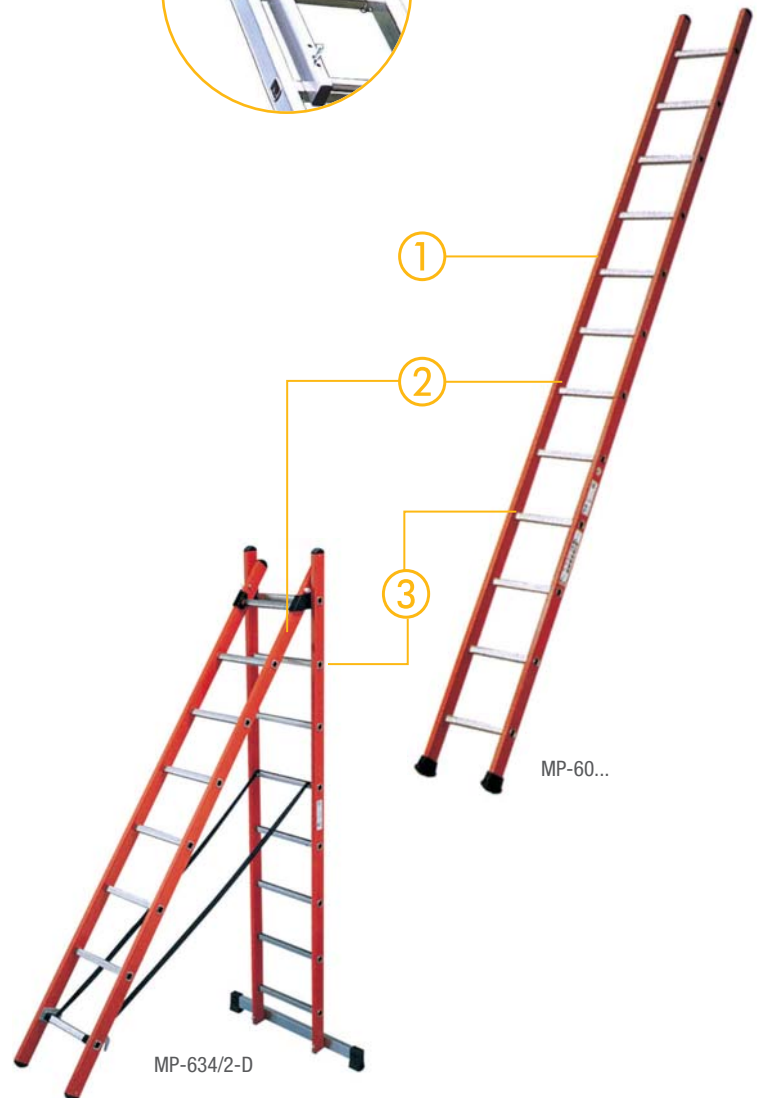
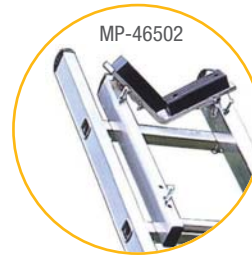

INSULATING SLIDE LADDERS

Agreement EDF/SPS N° B 216 - 0 - 635.

2 sections extension ladders, hand operated

Reference	Folded	Extended	Numbers of rungs	kg
MP-514/2	2.41 m	4.09 m	2 x 8	13.9
MP-515/2R	2.70 m	5.21 m	2 x 10	17

2 sections extension ladders, rope and pulley operated

Reference	Folded	Extended	Numbers of rungs	kg
MP-506/2	3.53 m	6.05 m	2 x 12	22.9
MP-508/2	4.66 m	8.30 m	2 x 16	35.4
MP-509/2	5.22 m	9.14 m	2 x 18	39.3
MP-510/2	5.78 m	10.26 m	2 x 20	43
MP-510/2-IQ	6 m	10.4 m	2 x 19	41

Ladders come with cradle, strap and front wheels.

THE +

- 1 For working live LV.
- 2 Lateral risers in polyester/ glass fiber rectangular section 70 x 25 mm. Aluminium alloy rungs with square.
- 3 Wheels.
- 4 Wheels + cradle.
- 5 29 x 29 mm section and anti-slip coating.

STANDARD EXTENSION LADDERS

Ladders for electrical work at height. Maximum load: 150 daN. Anti-slip aluminum rungs.

2 sections extension ladders, rope and pulley operated

Reference	Folded	Extended	Numbers of rungs	kg
MP-607/2-I	4.66 m	8.02 m	2 x 16	30.2
MP-608/2-I	5.22 m	9.14 m	2 x 18	34.4
MP-609/2-I	5.78 m	9.98 m	2 x 20	37.8

3 sections extension ladders, rope and pulley operated

Reference	Folded	Extended	Numbers of rungs	kg
MP-607/3-I	2.98 m	6.89 m	3 x 10	24.6
MP-608/3-I	3.82 m	8.86 m	3 x 13	34.6

Ladders delivered with cradle, strap and front wheels

THE +

- 1 Superior element lateral risers in polyester/ glass fiber.
- 2 Lower element in aluminium alloy.
- 3 Insulation polyamide hooves

NF EN 131-1
NF EN 131-2
NF EN 131-3
NF EN 50528

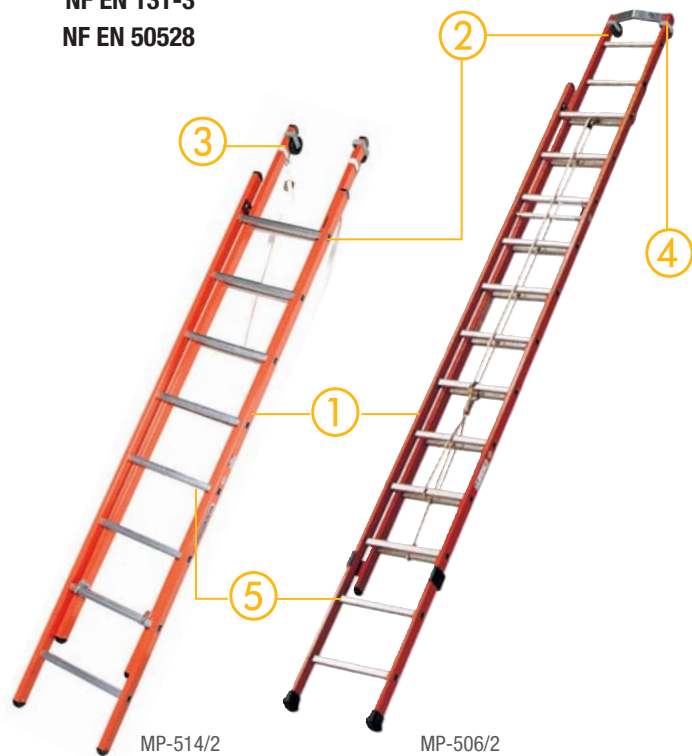

MP-514/2

MP-506/2

NF EN 131-1
NF EN 131-2
NF EN 131-3

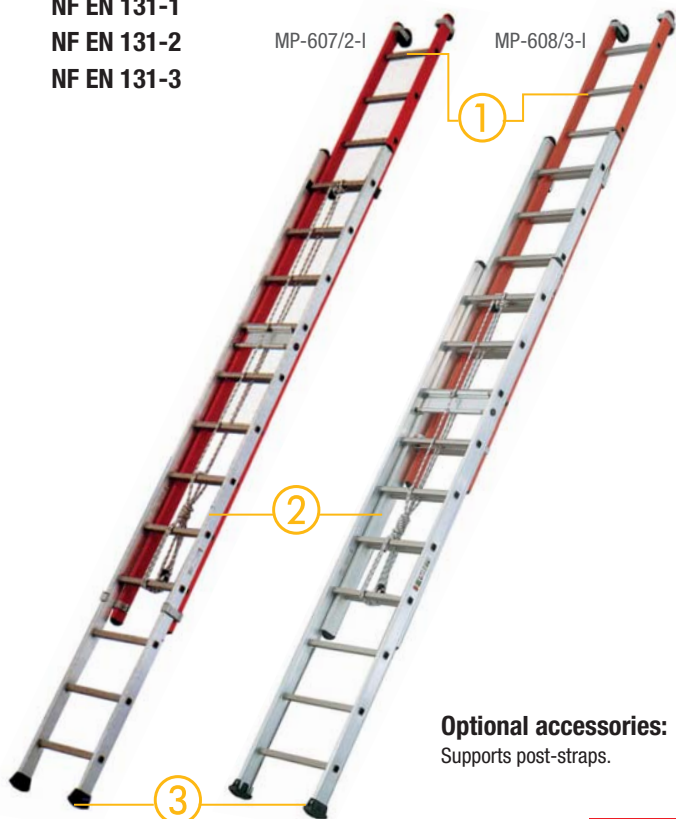

MP-607/2-I

MP-608/3-I

Optional accessories:
Supports post-straps.





STABILIZING COMPENSATOR LADDER

Stabilizer set to low level. Compensates for differences in height between the two uprights.

Reference	Spacing	Length	Spacing	For ladders	kg
MP-46500	30	50 to 70	390 to 440	MP-602-D • MP-603-D MP-604-D • MP-605-D MP-506/2 • MP-514/2 MP-515/2	4.4
MP-46501	35	75 to 95	420 to 470	MP-508/2 • MP-509/2 MP-510/2	4.7

THE +

- 1 Setting lever lock / unlock.

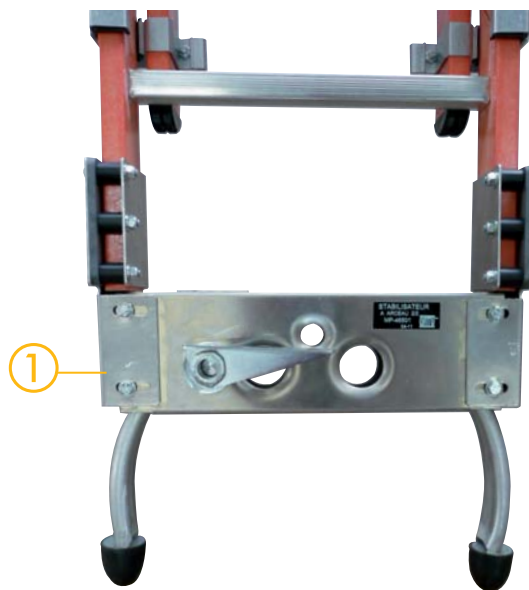

INSULATING STEPLADDERS

Compact stepladders with insulating uprights reinforced polyester fiberglass with light alloy steps to work at height. Insulation between two steps: 30 000 V. Maximum load: 150 daN. Anti-pinch finger joints.

Reference	Nbr steps	Height Access (m)	Height folded (m)	Height based feet (m)	kg
MP-700-4	3	2.58 m	1.39 m	0.68 m	5.9
MP-700-1	4	2.81 m	1.64 m	0.91 m	6.9
MP-700-2	5	3.04 m	1.89 m	1.14 m	8
MP-700-3	6	3.27 m	2.14 m	1.37 m	9.4
MP-700-5	7	3.50 m	2.39 m	1.60 m	11

Optional accessories:

Replacement kit clogs slip MP 700-100.
Replacement Kit toolholders MP 700-200.



THE +

- 1 Railing equipped with a toolholder (height 600 mm).
- 2 Slimline 8.8 cm.
- 3 Large uprights

NF EN 131
NF EN 50528



HOOVES AND DOOR INSULATION KITS TOOLS FOR INSULATING STEPLADDERS

Reference		
MP-700-100	150 x 150 x 60 mm	0.1
MP-700-200	280 x 150 x 100 mm	0.2

* Blister. ** Maximum load: 10 kg.



MP-700-100



MP-700-200



FOLDING STEPLADDER WITH RAILING



Secure non-insulating platform. Maximum working load 150 daN. Rung footrest tested 260 daN.

Reference	Nbr steps	Height Access	Height folded	Height based feet	
MP-700-6	4	2.93 m	1.48 m	0.93 m	19.5

Decrees 2004-924
6548 PIRL
NFP 93 353



THE

-  Seat belt.
-  Skirting on three sides.
-  Casters.





STACKABLE LADDERS ELEMENTS

Metallic elements: NF C 18-430. Upright duralinox.
 Insulation elements: IEC-61478 Class I. Glass-epoxy – non-slip bars, Orange color T.S.T. - B.T / H.T.A.

Reference	Elements type	↔	Nbr steps	kg
MP-402-MB	Metallic basic *	2.10 m	7	5.4
MP-403-MB		3 m	10	7.6
MP-402-MI	Metallic intermedia.	2.10 m	7	4.8
MP-403-MI		3 m	10	7
MP-501-D	Insulating BT / HTA	1.20 m	4	3.3
MP-502-D		2.10 m	7	5.8
MP-503-D		3 m	10	8.3

* Telescopic Feet.

Accessories or spare parts

Reference	Characteristics
MP-400	Set of 2 straps without screws
MP-400-2	Cradle replacement

THE +

- ① Metallic or insulating elements assembly with ferrules providing truncated pyramid accurate editing, secure and safe blocking.
- ② Cradles with straps for attachment to each element.

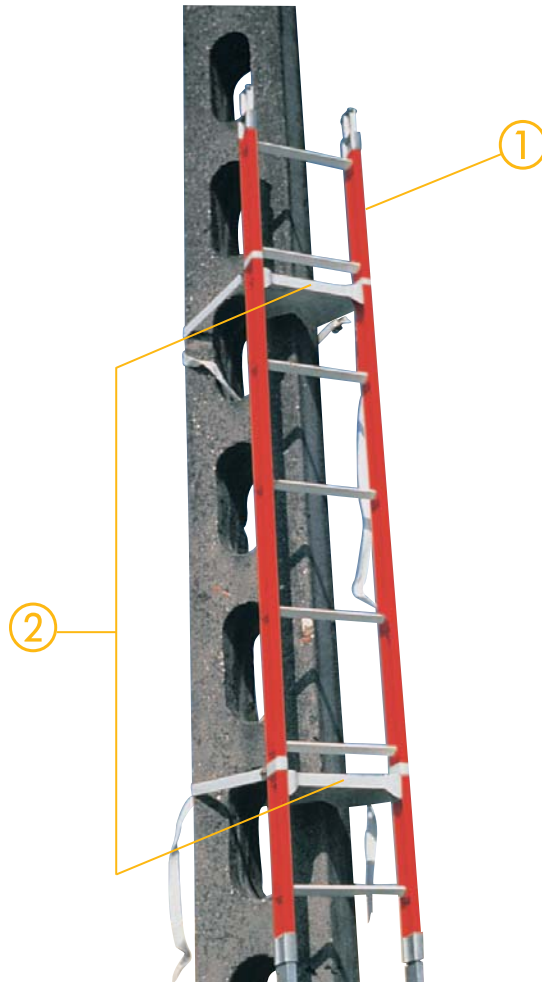

TELESCOPIC MEASURING STICKS

Measuring sticks for the height of conductors networks.
 Measurements can be made under tension (under the prescription **UTE 18-510**).

Reference	Characteristics
MO-831	Model LV-MV - EDF SPS Approval 18-132 A Max. 11 m - Length folded 1.5 m Usable on a 50 kV max. - 3.3 kg
MO-832	Transportation model HV - Max. 12 m Used on LV, MV and HV systems up to 220 kV Identical to other MO-831 features 2 live line elements
M-95-236	Measuring gauge diameters (3-20 mm)

THE +

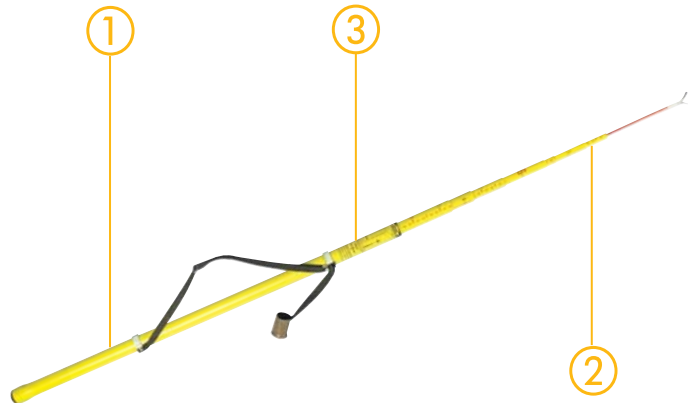

- ① 8 telescopic sections of insulated polyester glass, graduated and operated by a push-button mechanism
- ② Upper portion made of IEC 60855 orange reinforced synthetic material.
- ③ Direct Reading at the top of the 1st section of the stick, from 2.65 to 11 or 12 m. Graduation in m, dm and cm.



INSULATOR COVER

ST TST BT N°435 specification. For LV insulator. Synthetic orange colour rubber.





Reference	Characteristics		 mm	 kg
MP-22	Line insulator	H 150 mm	110	0.47
MP-23	Dead end insulator	H 210 mm	180	1.1

BAG FOR INSULATOR COVER

Steel suspension hook. Reinforced bottom and rope handle.





Reference	 mm	 kg
MP-50	Ø 300 x H 400	0.65

THE +

1 Strong waterproof.

END CAP FOR CONDUCTOR CABLE

ST TST BT N°430 specification. Insulation of bare ends of LV cables

Reference	 Ext mm	 In mm		Section mm ²
MP-26-A	10	6.5	6 cm	4 to 10 mm ²
MP-26-B	15	11	10 cm	10 to 35 mm ²
MP-26-C	20	15	12 cm	16 to 70 mm ²
MP-26-D	25	20	12 cm	25 to 120 mm ²
MP-26-E	35	30	12 cm	to 300 mm ²

THE +



1 Cylindrical cap made of flexible insulating material.

2 With cross-shaped opening.



FLEXIBLE - TYPE CONDUCTOR COVER

ST TST BT N°440 specification. For LV conductors. Shape type Ω, thickness 3.3 mm. For conductor Ø 16 mm max.

Reference		 kg
MP-32/10	1 m	0.4
MP-32/15	1.5 m	0.6
MP-33	3 m	1.2



FLEXIBLE - TYPE CONDUCTOR COVER

ST TST BT N°445 specification. For overhead network (< 1000 V). For conductor Ø 20-22 mm.

Reference	Characteristics	 kg
MP-31	Spiral shape type 5 m	0.6
MP-59	Indent tool for MP-31	0.18





Insulating flexible blanket

ELECTRICAL INSULATING BLANKET

The electrical insulating blanket is used for the protection of workers from accidental contact with live or earthed electrical conductors, apparatus or circuits and avoidance of short circuits on electrical installations.



ELECTRICAL INSULATING BLANKET IN ACCORDANCE WITH IEC 61112 STANDARD

According class 0 specifications. Operating voltage: 1000 V AC and 1500 V DC.

In accordance with specific properties:

Category A: acid resistant.

Category C: resistant to very low temperature (-40°C).

Category H: oil resistant.

Recommendations for use

Storage/Transport

Insulated blanket should be properly stored to avoid the risk of damage to the insulating material. Do not store or use close to excessive heat. Do not expose to direct sunlight for long period. Storage temperature: 10°C to 21°C.

Before use

Insulating blanket cut from a roll should keep visible markings. Each side of the blanket should be visually inspected by the user. The insulating blanket must not have tears or holes. If the blanket is dirty, wash it with soap and water. Dry it with respect of using temperatures.

In use

Operating temperatures: -40°C to +55°C. Avoid contact with chemical products. Do not walk on the insulating blanket.

Periodic inspection

Insulating blanket should not be used without having been electrically tested within twelve months preceding with the exception of class 00 and 0. Only visual inspection is required for class 00 and 0.

ACCESSORIES SEE PAGE 70

Clamp and adhesive tape.





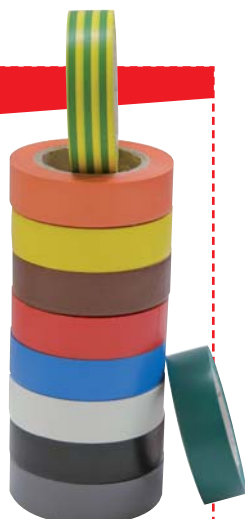

MP-41530

MP-19-LOT





INSULATING FLEXIBLE BLANKET

Polyvinyl in roll. IEC 61112 – class 0 ⚠

Reference	Class	Voltage 	Voltage 	 m	 mm	 kg
MP-35	0	< 1 000 V	< 1 500 V	1.3 x 25	0.3	12
MP-35/12	0	< 1 000 V	< 1 500 V	1.3 x 12.5	0.3	6
MP-37	0	< 1 000 V	< 1 500 V	0.09 x 25	0.3	0.8

In accordance with ST HTA 50D EDF-SERECT specification.

Reference	 m	 mm	 kg
MP-40	1.3 x 25	0.8	24



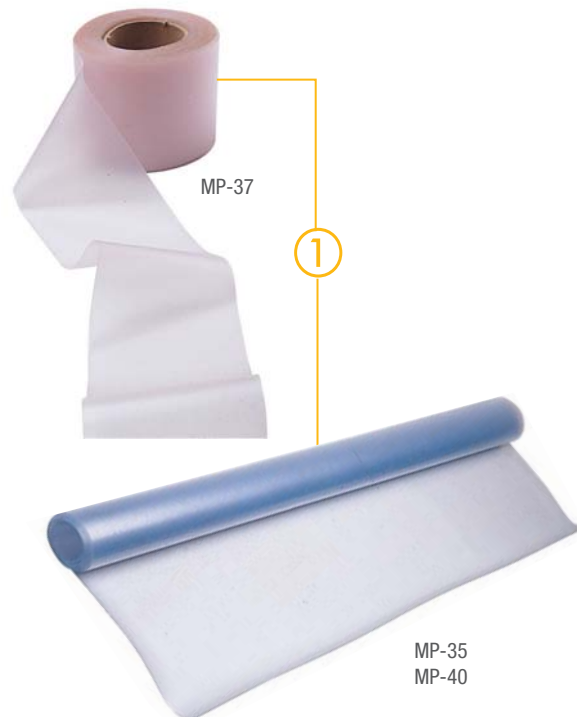

THE

- 1 Flexible translucent polyvinyl. Fastening with clamps or adhesive tape.



INSULATING FLEXIBLE BLANKET ORANGE RUBBER

IEC 61112 – class 0 ⚠

Reference	Class	Voltage 	Voltage 	 m	 mm	 kg
MP-220	0	< 1 000 V	< 1 500 V	1 x 1	1	1.5
MP-220/1	0	< 1 000 V	< 1 500 V	1 x 10	1	15





THE

- 1 High resistance with perforation.



INSULATING FLEXIBLE BLANKET REINFORCED POLYVINYL

Individual model. IEC 61112 – class 0 ⚠

Reference	Class	Voltage 	Voltage 	 mm	 mm	 kg
MP-123	0	< 1 000 V	< 1 500 V	360 x 660	0.5	0.15
MP-123/1	0	< 1 000 V	< 1 500 V	500 x 900	0.5	0.3
MP-123/2	0	< 1 000 V	< 1 500 V	800 x 1 200	0.5	0.6

THE

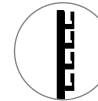

- 1 Translucid polyvinyl. Reinforced by a grid of synthetic fibre.
- 2 The «Velcro™» type allows the flexible blankets to be closed by pressing the edges together. Several flexible blankets can also be connected in this manner.







BLANKET CLAMP

ST TST BT N°415 – Class 0

Reference	↔ mm		
MP-4110	160	1	60
MP-41530	65	12	10



DIN VDE 0680-1 – Class 0

Reference	↔ mm		
MP-625-D	160	1	70
MP-627-D	80	3	30





THE ⊕

- ① Insulating plastic clamp with spring.
- ② Bimaterial insulating clamp.
- ③ Fully insulating pliers.
- ④ Great pinching force.

ELECTRICAL ADHESIVE TAPE

High quality electrical insulation tape which is self-extinguishing. Class 0

Reference	 m	
MP-19-LOT	0.015 x 10	Set of ten rolls*

* Brown, yellow, red, orange, blue, white, black, green, green/yellow, grey.

IEC EN 60454



Locking



Locking padlocks	73
Multiple lockers	76
Circuit breaker lockers	78
Padlock stations	80
Circuit breaker lockers, panels and insert	81
Fluid locking	82
Cabinets	84
Lock-out kits	85





LOCKING, an essential stage for lockout.

Depending on the environments, default lockout accidents are caused by the:

- Continued presence of live conductor parts for electrical installations.
- Presence of pressurized fluids (hydraulic circuits).
- Presence of unstable mechanical systems.

The corresponding recommendations must be applied for each risk, but in all cases specific locking with regard to the risk considered must be set up.

Sometimes the overall analysis of risks reveals a combination of the different risks which makes a more extensive locking operation mandatory. This is especially the case with electricity production equipment.



What does locking mean?

The purpose of locking is to separate cut off or neutralisation parts with a suitable, and sufficiently protected system to prevent any operation by unauthorised persons (switching on power for an electrical installation). Locking is generally accompanied by signs.

For the electrical domain, setting up and removing the lockout are described in national and European standards (EN50110-1).

For electricity production equipment.

More generally, the safety recommendations are included in Directive CE7: 2009/104/EC on the minimum health and safety recommendations for using work equipment



THE RANGE

- 1 For all locks A-76230 additional key (specify the key number). Anti-corrosion brass handle.
- 2 Marking on both surfaces: standardized symbol/User identity.





















SPECIAL MODELS WITH PICTOGRAMS

Reference	Shackle		
	↑ mm	∅ mm	
AL-230-(**)-EX	50	6	204
AL-230-S-(**)-EX	70	6	214
AL-230-Z-EX	50	6	204
AL-230-S-Z-EX	70	6	214
AL-240-(**)-EX	50	4	192
AL-240-S-(**)-EX	70	4	198
AL-240-Z-EX	50	4	192
AL-240-S-Z-EX	70	4	198

(**) Add key number : 111 or 222..



COLOUR MODELS







Reference	Shackle		Colour	
	↑ mm	∅ mm		
AL-240-B-111-EX	50	4		192
AL-240-B-Z-EX	50	4		192
AL-240-B-00-EX	70	4		192
AL-240-S-B-111-EX	70	4		198
AL-240-S-B-00-EX	70	4		198
AL-240-J-111-EX	50	4		192
AL-240-J-Z-EX	50	4		192
AL-240-J-00-EX	50	4		192
AL-240-S-J-111-EX	70	4		198
AL-240-S-J-00-EX	70	4		198
AL-240-BL-111-EX	50	4		192
AL-240-BL-Z-EX	50	4		192
AL-240-BL-00-EX	50	4		192
AL-240-S-BL-111-EX	70	4		198
AL-240-S-BL-00-EX	50	4		198
AL-240-V-111-EX	50	4		192
AL-240-V-Z-EX	50	4		192
AL-240-V-00-EX	50	4		192
AL-240-S-V-111-EX	70	4		198
AL-240-S-V-00-EX	70	4		198

(*) Key on request.



MODELS WITH INSULATED SHACKLE

Shackle covered with insulating red PVC. With insulating red PVC 1000 V AC.

Reference	Shackle		Colour	
	↑ mm	∅ mm		
AL-260-(**)-EX	50	6.2		200
AL-260-00-EX	50	6.2		200
AL-260-Z-EX	50	6.2		200
AL-260-S-(**)-EX	70	6.2		210
AL-260-S-00-EX	70	6.2		210
AL-260-S-Z-EX	70	6.2		210

(**) Add the key numbers 111 or 222 only.



For any padlock A-76230 Additional key (specify key number)

 Weight  mm Total height  Diameter



Choose your locks!

A COMPLETE LINE OF AL PADLOCKS TO MEET ALL OF YOUR NEEDS

Shackle diameter			Shackle length		Body colours					Keys			Stickers
Ø 6.2 mm	Ø 4 mm	Ø 6 mm	50 mm	70 mm	Red	White	Yellow	Blue	Green	Standard	Random	Upon request	Picto
260	240	230	-	S	-	B	J	BL	V	(**)	Z	00	EX
Aro aislado													

TO ORDER YOUR PADLOCKS

Bill of material as a reference for your padlocks:

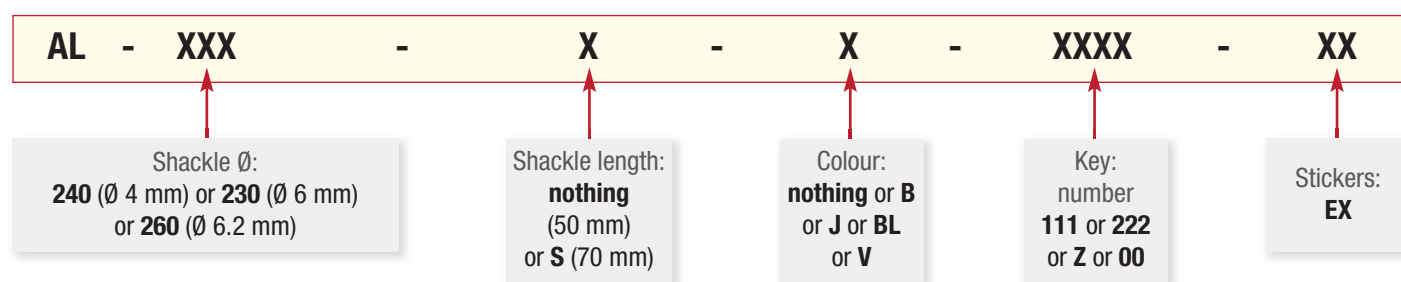

1st example :

Insulated shackle Ø 6.2 mm **AL-260**
 Shackle Lg 50 mm -
 Standard colour (red) -
 Key n°222 **222**
 Sticker with picto..... **EX**
 Your reference: **AL-260-222-EX**



2nd example :

Shackle Ø 4 mm **AL-240**
 Shackle Lg 70 mm **S**
 Colour blue..... **BL**
 Key upon request..... **00**
 Sticker with picto **EX**
 Your reference: **AL-240-S-BL-00-EX**



Codes or key numbers

(**): Key number 111 or 222.

Z: Number of random key (at random).

00: Key number on request.



TABLES OF POSSIBLE COMBINATIONS

Key	Sticker	AL-240 (Ø 4 mm)										AL-230 (Ø 6 mm)																
		-(Shackle 50 mm)					-S (Shackle 70 mm)					-(Shackle 50 mm)					-S (Shackle 70 mm)											
		-	B	J	BL	V	-	B	J	BL	V	-	B	J	BL	V	-	B	J	BL	V							
(**)		•	•	•	•	•	•	•	•	•	•	•											•					
Z		•	•	•	•	•																						
00		•	•	•	•	•	•	•	•	•	•												•					

Key	Sticker	AL-260 (Ø 6.2 mm - insulated shackle)									
		-(Shackle 50 mm)					-S (Shackle 70 mm)				
		-	B	J	BL	V	-	B	J	BL	V
(**)			•					•			
Z		•					•				
00		•	•				•	•			

• Existing padlocks.





Download our
LOCKOUT/TAGOUT
SOLUTIONS on
www.catuelec.com



Multiple lockers

THE ⊕ RANGE

- 1 To lock simultaneously the same piece of equipment through several persons.
- 2 Impossible to open as long as the last lock has not been removed.

FLEXIBLE MODELS

Nylon (non-conductive). Warning label "Danger" and identification of the person during the intervention. 3 or 6 locks possible.

Reference	Shackle ↑ mm	Locks	Holes ∅ mm	Length ← mm	Weight g
ALP-03	50	3	9	105	20
ALP-06	80	6	9	183	30



ALL-PLASTIC MODELS

Label with 'DANGER' warning and identification of the person carrying out the work.

Reference	Shackle ↑ mm	Holes ∅ mm	Locks	Holes ∅ mm	Length ← mm	Weight g
ALP-4/3	46	3	4	8	108	35
ALP-4/6	46	6	4	8	108	35



UNIVERSAL MODEL

Maximum weight supported: 100 kg. 'DANGER' warning label.

Reference	Cable	Locks	Holes ∅ mm	Weight g
ALP-12/2M	∅4 Lg 2m	12	9	130

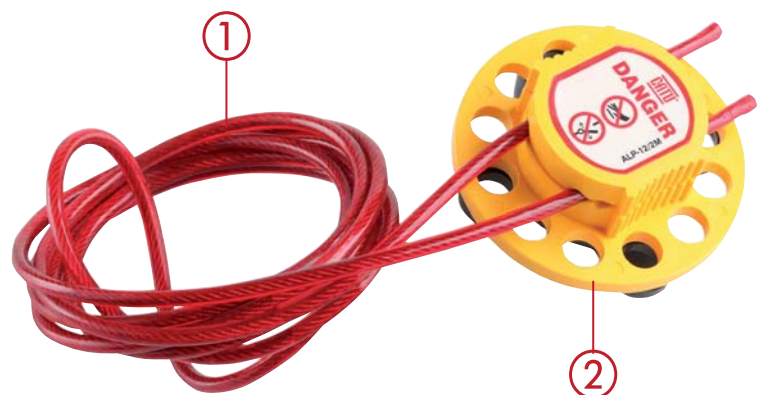

THE ⊕

- 1 Steel cable coated in non-conductive PVC.
- 2 Holds up to 9 padlocks. Nylon body.

METAL MODELS

Made of anti-corrosion metal. Holds up to 4 padlocks of Ø 6 mm max (AL-203, AL-230 or AL-240).

Reference	mm	Description	g
AL-200	100 x 60 x 10	EDF type A	150
AL-202	165 x 50 x 12	EDF type B	200

Safety padlock

Reference	mm Shackle	mm Shackle	g
AL-203*	6	50	180

* Key n°111.

THE +

1 Allows hanging a prohibition disk.

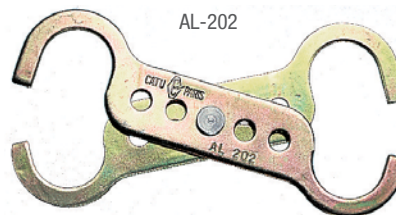
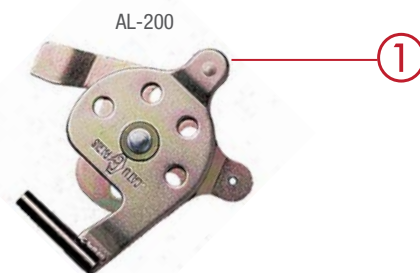

HASP MODELS

Made of high-resistance steel.

Reference	Clamping mm	Locks	Holes mm	mm	g
ALM-6/25	25	6	9	112	95
ALM-6/38	38	6	9	125	110
ALM-20/45	20 & 45	6	9	138	120

THE +

1 Double sided. Holds up to 6 padlocks.

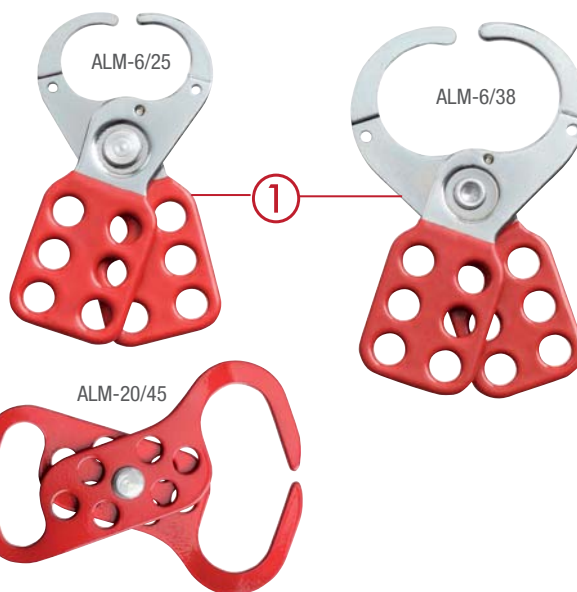

STEEL SHACKLE MODEL

Label with 'DANGER' warning and identification of the person carrying out the work. High-strength steel shackle and body.

Reference	Shackle		Holes mm	mm	g
	mm	mm			
ALM-6/8	25	5	8	115	80

THE +

1 High-strength steel shackle and body.





mm Total height mm Total length Locks Number of locks
 mm Diameter Cable mm Dimensions g Weight



CLIPBLOCK™ SMALL MODEL

Quick fitting with a no. 3 flat screwdriver. Highly compact and can be padlocked. Prohibition sign. Delivered in blister pack.

Reference	Description and 	
AL-201/1	5 units, no padlock	158
AL-201-C/1	Delivered with 1 padlock *	60
AL-216	Padlock only, steel shackle Ø 3 mm	16

* Key on demand.





THE

- Compatible with all the brands of modular circuit breaker lockers, switches and differentials.



MULTIPLE MODEL

Suitable for all types of low voltage protection unit locker. Particularly suited to the CLIPBLOCK™ circuit breaker locker. High resistance plastic cord. Length 2 m or 5 m. ABS body for use with Ø 4 to 6 mm padlocks.

Reference	Description and 			
AL-205	Supplied with 2 m PVC cord	3	6	110
AL-205/5	Supplied with 5 m PVC cord	3	6	160

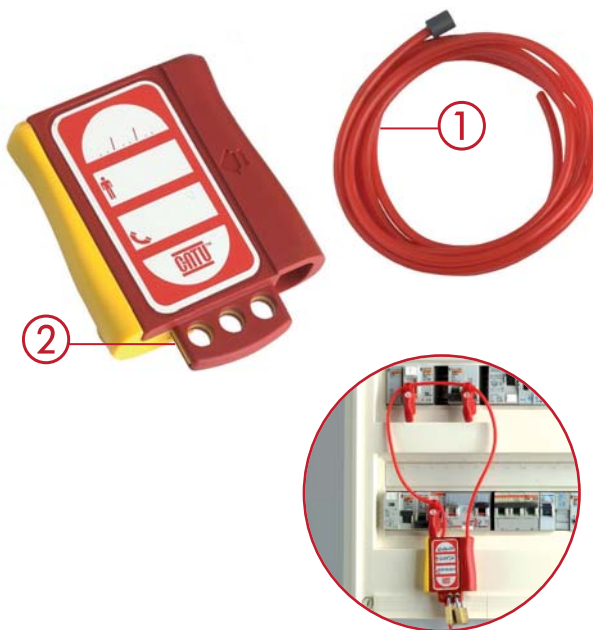

THE

- Cable with plastic stopper to use in loop or single cord.
- Allows to deport the padlock in case of lack of space.



MEDIUM-SIZE MODELS

Red plastic. No tool needed for installation (tightened manually).

Reference	Holes Ø mm	Screw	 mm	
AL-208-C *	8	Stainless steel	52 x 25	20
AL-208-D **	8	Stainless steel	52 x 33	20

* Bent snipe nose. ** Straight.

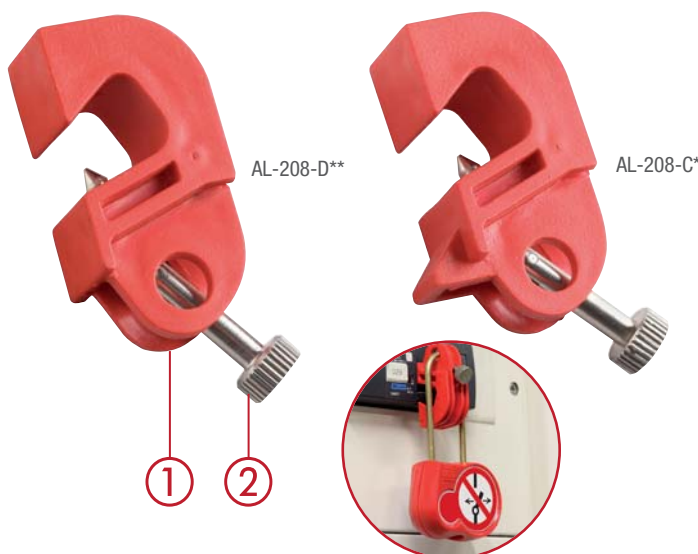

THE

- No tools needed for installation (tightened manually).
- Trip worm to allow space for the padlock shackle.



LARGE MODEL

No tool needed for installation. Turn the screw in the circuit breaker handle and add one or more padlocks and a warning label.

Reference		Holes mm	For levers mm		
AL-209-L	12	8	76 x 23	105 x 95	66



THE

1 Easy installation without tools.



MODEL FOR MOULDED UNITS

Suitable for Schneider circuit breakers with the following references: NS80, NSE75/NSE100, NS100/NS160/NS250, NSF150/NSF250, NS400/NS630, NSJ400/NSJ600.

Reference		Holes mm		
AL-204	3	8	37 x 49 x 4*	32

* Closed.



BADGE MODELS

Ø 10mm hole for attachment on the upper part.





Reference		Type
AM-467-GB	80	Aluminium
AP-499/1	100	Plastic



AM-467-GB



AP-499/1

 Diameter
 Number of locks
 Packaging
 Dimensions
 Weight





Padlock stations

YELLOW PVC HANDLE MODEL

Fitted to the belt so as to free up the hands. Key ring incorporated into the handle. Label system ensures that the user knows that all the power sources have been locked out.

Reference		Holes ∅ mm	 mm	 g
AL-212	12	9	190 x 130	120

THE

- 1 Yellow PVC.
- 2 Holds up to 12 padlocks.

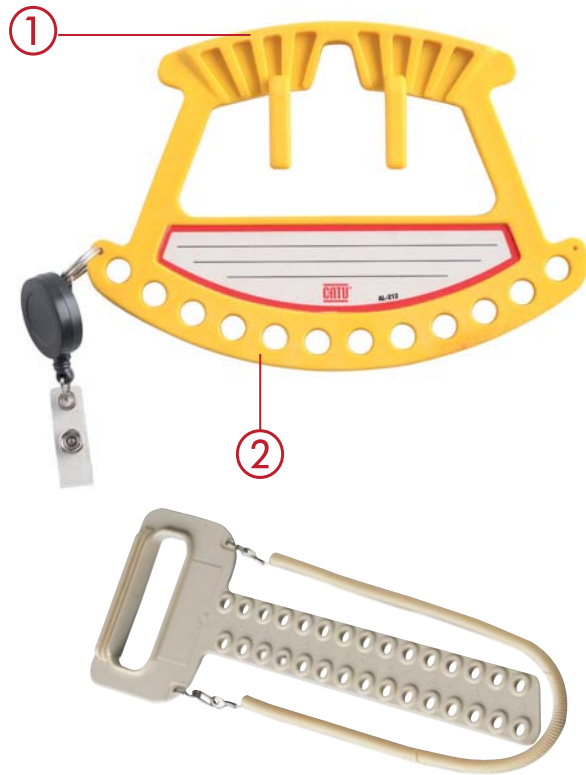

IVORY HANDLE MODEL

Ivory white PVC. High resistance to impacts. Holds up to 30 padlocks.

Reference		Holes ∅ mm	 g
AL-207/30	30	9	130

'LOCKOUT MANAGER' MODEL

Handle dimensions 156 x 73 x 12 mm.

Reference		 kg
AL-206	0 (Handle only)	0.15
AL-236-111-EX	6 (AL-230-111-EX)	1.15
AL-236-222-EX	6 (AL-230-222-EX)	1.15
AL-236-S-111-EX	6 (AL-230-S-111-EX)	1.21
AL-236-S-222-EX	6 (AL-230-S-222-EX)	1.21
AL-236-00-EX	6 (AL-230-00-EX *)	1.15
AL-236-S-00-EX	6 (AL-230-S-00-EX *)	1.21

00: key number on request.

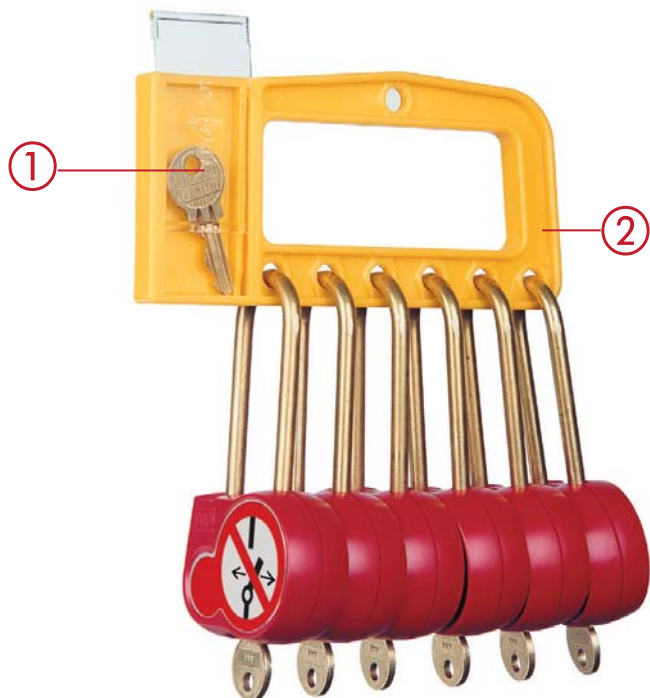

THE

- 1 Compartment with transparent cover for key storage.
- 2 Plastic handle with 6 padlocks that are all opened with the same key.



WALL SUPPORT FOR PADLOCKS





Red-painted metal wall support. Fixation hole.

Reference		 mm	 g
RL-100	12	175 x 71 x 31	65



ELECTRICAL OR PNEUMATIC SOCKET LOCKERS

Polystyrene. Electrical or pneumatic socket locker device. Easy to install with the two articulated parts. Padlock locking.

Reference	Holes  mm		For cable  mm	 mm	 g
PL-100	9	2	12	88 x 50 x 50	56
PL-101	9	4	25	171 x 83 x 83	211







PL-100

THE

 Holds up to 4 padlocks.

MACHINE CONTROL LOCKER

Red fabric and black leather. Locking device for the control units of numerical machines, cranes, winches, overhead cranes. Padlock locking.

Reference	Holes  mm		 mm	 g
PL-102	11	6	460 x 210	65







THE

 Holds up to 6 padlocks.



MODELS FOR GATE VALVES

Polyurethane. Easy to install with the two articulated parts*. Padlock locking.



Reference	Holes ∅ mm	Lock	Gate* ∅ mm	Int. ∅ mm	↑ mm	g
HL-100	10	1	25 to 63.5	69	35	69
HL-101	10	1	63.5 to 127	130	46	211
HL-102	10	1	127 to 165	170	54	336
HL-103	10	1	165 to 254	267	70	670
HL-104	10	1	254 to 330	354	70	1150
HL-105	10	1**	25 to 165	170	53	243

* Except HL-105, 2 parts. ** 4 position settings.



HL-105



THE ⊕

- ① Prevents any handling of the gate valve.
- ② Adjustable model

MODELS FOR 1/4 TURN VALVES

Polyurethane. Easy to adjust with the two clip-in parts. Padlock locking that prevents any quarter turn handling.

Reference	Holes ∅ mm	Lock	Locking	←→ mm	g
HL-200	7	1 ⁸ positions	45 to 125	140	155
HL-201	7	1 ¹³ positions	50 to 190	254	230
HL-202	9	1 ¹² positions	75 to 215	295	580



THE ⊕

- ① 8 adjustment positions.
- ② 13 adjustment positions.
- ③ 12 adjustment positions.

UNIVERSAL MODEL

Polypropylene. For locking all types of valves: 1/4 turn, butterfly, etc.

Reference	Holes ∅ mm	🔒	Locking	↔ mm	📊 g
HL-203	9	1 padlock 9 positions	95 to 255	300	285

THE +

1 Adjustable model.

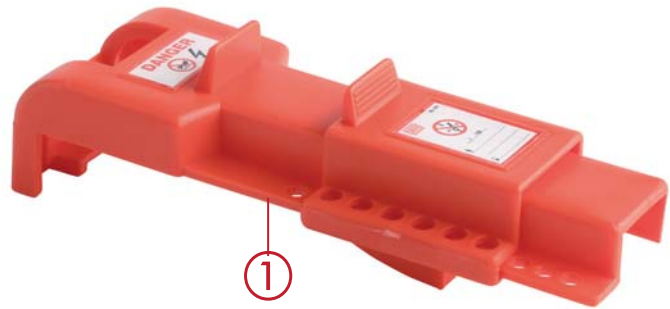

GAS BOTTLE MODELS

Polystyrene. Gas bottle locker device (propane, butane, etc.).

Reference	Holes ∅ mm	🔒	Locking	□ mm	📊 g
GL-100	7	1	29	∅ 70	60
GL-101	7	1	35	∅ 85-L150	135

THE +

1 Easy to install with the two articulated parts.



GL-101





GL-100





LOCKOUT CABINET

Two adjustable shelves (12 positions). Locked by key. Delivered empty with attachment pegs and screws. Optional accessories.

Reference	 mm	 kg
SL-101	405 x 355 x 156	5.6



THE

- 1** Shelves with rim preventing the fall of objects.
- 2** Versatile : for wall mounting and hand carrying, thanks to an integrated reversible handle.



STORAGE CABINET

Locked by key. Delivered with 4-level padlock support, attachment pegs and screws. Optional padlocks.

Reference		 mm	 kg
SL-102	42	465 x 395 x 55	4.5

THE

- 1** Support padlock at adjustable height.



GENERAL CONSIGNMENT KIT

Composition	Reference: KIT-CONSI01G GB	Quantity
M-87370	Storage bag	1
AL-240-Z-EX	Padlock with shackle 50 mm and Ø 4 mm	2
ALM-6/25	Hasp	1
ALP-4/6	Multiple locker	1
ALP-12/2M	Universal multiple locker	1
HL-105	Fluid locking for gate valves (Ø 25 to 165 mm)	1
HL-200	Fluid locking for gate valves (locking from 9.5 to 31.75 mm)	1
HL-201	Fluid locking for 1/4 turn valves (locking from 38 to 63.5 mm)	1
AM-467-GB	Locking « badge model »	10



M-87370



AL-240-Z-EX



ALM-6/25



ALP-4/6

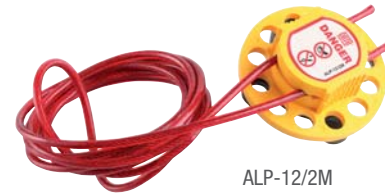

ALP-12/2M



HL-200



HL-200



AM-467-GB



HL-105



ELECTRICAL CONSIGNMENT KIT

Composition	Reference: KIT-CONSI01E GB	Quantity
AL-260-Z	Padlock with shackle 50 mm and Ø 4 mm	1
M-87292	Storage bag	1
AL-240-Z	Padlock with shackle 50 mm and Ø 4 mm	1
AL-205	Hasp	1
ALM-6/25	Hasp	1
ALP-06	Multiple locker	1
AL-201/C1	Universal multiple locker	1
AL-208-D	Medium size circuit breaker locker	1
AL-208-C	Medium-size circuit breaker locker	1
AL-209-L	Large circuit breaker locker	1
AM-467-GB	Locking « badge model »	2



M-87292



AL-260-Z-EX



AL-240-Z-EX



ALM-6/25



ALP-06



AM-467-GB



AL-209-L



AL-208-D



AL-208-C



AM-467-GB



AL-205





CIRCUIT BREAKER CONSIGNMENT KIT

Composition	Reference : KIT-CONSI01D GB	Quantity
AL-201/C1	Small circuit breaker locker with padlock	3
AL-208-D	Medium-size circuit breaker locker	3
AL-209-L	Large-size circuit breaker locker	1
AM-467-GB	Locking « badge model »	5
M-87290	Storage bag	1



AL-209-L



AL-201/C1



AL-208-D



AM-467-GB



M-87290



Download our
LOCKOUT/TAGOUT
SOLUTIONS on

www.catuelec.com

Signaling



Warning signs

88

Signaling and delineators

91





Warning signs

WARNING SIGNS

Special tool steel, oil-hardened.

Reference	Type	mm	Colour
AM-344-GB	aluminium	100 mm side	black letters on yellow
AM-345-GB	aluminium	100 mm side	black letters on yellow
AM-344	aluminium	100 mm side	black & yellow
AM-344/05	aluminium	50 mm side	black & yellow
AM-49/1	aluminium	100 mm side	black & yellow
AM-49/2	aluminium	200 mm side	black & yellow
AM-41/1	aluminium	100 mm side	black & yellow
AM-41/2	aluminium	200 mm side	black & yellow
AM-467-GB	aluminium	Ø 100 mm	white letters on red
AP-499/1	plastic	Ø 100 mm	white & red
AM-20-GB	aluminium	270 x 300 mm	blue letters plain aluminium
AP-510-BT-GB	plastic	297 x 210 mm	golden rules



AM-344-GB



AM-345-GB



AM-344 - AM-344/05

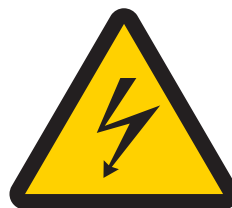

AM-49/...



AM-41/...



AM-467-GB

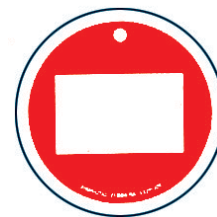

AP-499/1

FIRST AID FOR ELECTRIC SHOCK VICTIMS
Do not lose a second.

PROTECT THE VICTIM
Switch off the power to protect the victim from the effects of the current.
If it is not possible for the rescuer to switch off the power, alert the distributor.
ANY RECKLESS INTERVENTION BY THE RESCUER MAY EXPOSE HIM TO SHOCKS AS WELL.

CALL EMERGENCY SERVICES
ACCORDING TO PREDEFINED INSTRUCTIONS

Fire brigade: _____
Ambulance: _____
Police: _____
Company emergency service no: _____

ASSIST THE VICTIM
ENSURE BREATHING
If the victim is unconscious and does not breathe, with no sign of breathing:

1. Lay the victim on their back and raise the chin.
2. Watch and listen for breathing.
3. When necessary, reposition the victim's head.
4. Start any resuscitation in a safe position, taking all care.
5. When the victim is breathing, support his head.

NEVER ABANDON FIRST AID BEFORE SPECIALIST SERVICES ARRIVE

AM-20-GB

DEAD WORKING LOW VOLTAGE
GOLDEN RULES

- 1. Select the right equipment**
Four elements: Insulating gloves, Padlock, Voltage detector, Insulating mat or platform, Short-circuiting system.
- 2. Isolate the work area from all sources of power supply**
- 3. Lock the circuit breaker in the open position**
- 4. Check the absence of voltage**
- 5. Apply appropriate short-circuiting and earthing systems**
- 6. Show, warn others and isolate the work area from the close vicinity**

In conformity with EN 50110 - NF C 15-510 - Decree n°2010-1156 du 23/09/2010

AP-510-BT-GB

SUBSTATION SIGNS

Specialist signs.

Reference	Type	mm	Colour
AM-61-GB	aluminium	200 x 150 mm	
AM-61-RM	aluminium	200 x 150 mm	
AM-282/2-RM	aluminium	200 x 60 mm	
AM-7002	aluminium	200 x 150 mm	black & yellow
AM-32/3	aluminium	∅ 300 mm	white & red
AM-33/3	aluminium	∅ 300 mm	red/black on alu
AM-34/2	aluminium	∅ 200 mm	red/black on alu
AP-951/2	plastic	200 x 200 mm	white & red
AP-510-GB	plastic	420 x 297 mm	golden rules
AM-20-RM	aluminium	500 x 350 mm	blue letters on plain aluminium



AM-61-GB



AM-61-RM



AM-282/2-RM



AM-7002



AM-32/3



AM-33/3



AM-34/2



AP-951/2

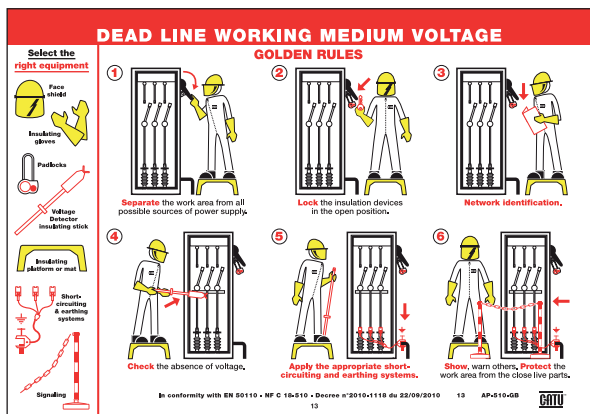

AP-510-GB



AM-20-RM



Warning signs



SELF ADHESIVE WARNING SIGNS

Complete range of self adhesive, warning signs packed in box of 20, 30 or 50 units.



Reference	mm	
AT-41/025	25 mm side	50
AT-41/05	50 mm side	30
AT-41/1 **	100 mm side	20
AT-49/025	25 mm side	50
AT-49/05 **	50 mm side	30
AT-49/1 **	100 mm side	20
AT-50/025	25 mm side	50
AT-50/053	50 mm side	30
AT-50/1	100 mm side	20
AT-51/025	25 mm side	50
AT-51/05	50 mm side	30
AT-51/1	100 mm side	20
AT-52/05	50 x 25 mm side	30
AT-52/1	100 x 50 mm side	20
AT-53/05	50 x 25 mm side	30
AT-53/1	100 x 50 mm side	20
AT-54/05	Ø 50 mm	30
AT-54/1	Ø 100 mm	20
AT-55/05	Ø 50 mm	30
AT-55/1	Ø 100 mm	20
AT-56/05	Ø 50 mm	30
AT-56/1	Ø 100 mm	20
AT-58/05	Ø 50 mm	30
AT-58/1	Ø 100 mm	20
AT-59/05	Ø 50 mm	30
AT-59/1	Ø 100 mm	20
AT-60/05	Ø 50 mm	30
AT-60/1	Ø 100 mm	20
AT-61/05	Ø 50 mm	30
AT-61/1	Ø 100 mm	20
AT-62/05	Ø 50 mm	30
AT-62/1	Ø 100 mm	20
AT-63/05	Ø 50 mm	30
AT-63/1	100 mm side	20

* Available in pack of 500, references : AT-41/1-500, AT-49/1-500 and AT-49/05-500.

WARNING FLAGS

Brightly colored ribbon.

Reference	mm	Fixing
AL-53	350 Width x 650 Height	Fixing on handle.



AL-53



GROUNDING FLAGS

Vinyl coated fabric.

Reference	mm	Fixing
AL-58	338 Base x 365 Height	Fixing on handle; for work site 0.75 m
AL-60	338 Base x 365 Height	Fixing on earthing cable; for immediate identification in open-type switchgears possible inscription: 0 to 99 (by using ALU-SCRIPT markers)



AL-58

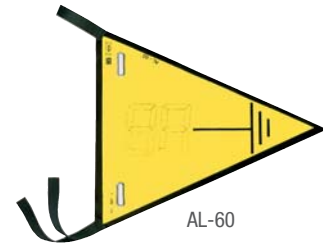

AL-60



SAFETY BOUNDARY POST

For temporary installation used with tough link chain delineators.

Reference	mm	Description	kg
AL-316 *	Length: 90 cm	Red & white	4.2
AL-318 **	Length: 90 cm	Black & yellow	4.2

* Use with chain delineators AL 31/05 and 31/25.

** Use with chain delineators AL 32/05 and 32/25.



AL-316

Marker post on a flexible base.



AL-318

Reference	mm	Description	kg
AL-321 *	Length: 90 cm	Red & white	0.65
AL-322 **	Length: 90 cm	Black & yellow	0.65
AL-323 *	Length: 90 cm	Red & white	4.2
AL-324 **	Length: 90 cm	Black & yellow	4.2

* Use with chain delineators AL 31/05 and 31/25.

** Use with chain delineators AL 32/05 and 32/25.



AL-321

Weighted base.



AL-322



AL-323

Concrete base.



AL-324





FIXING TOOLS FOR WARNING SIGNS

Reference	Characteristics
AC-21	Small nickelled chain sold in bags of 10 units. Dim 2 x 11 cm
AD-01	Roundheaded screw anti-vandalism M3x15 sold in bags of 100 units.
AC-44	Self-adhesive plastic plates Ø 40 mm for magnetic fixing (10 units).



AC-21



AC-44



AD-01

SAFETY ADHESIVE TAPE

Reference		Description
AT-5005	100 m Length x 50 mm Width	Adhesive tape black and yellow.



AT-5005

TEXTILE TAPE DELINEATORS

Reference		Description
AL-127	50 m Length x 50 mm Width	Red & yellow
AL-129	50 m Length x 50 mm Width	Red & yellow
AL-138	500 m Length x 80 mm Width	Red & white

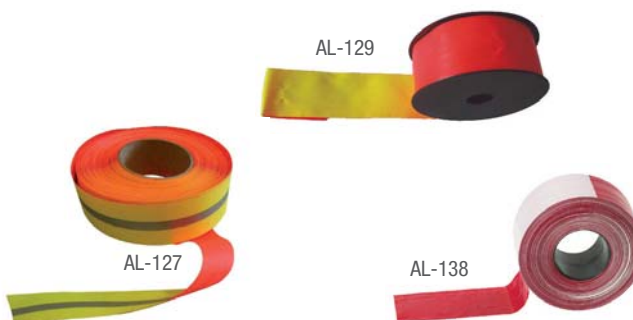

AL-127

AL-138

TEXTILE TAPE DELINEATORS

Reference		Description
AL-62-A	20 m Length x 50 mm Width	Red
AL-63-A		Yellow
AL-65-A		Replacement ribbon*

* For AL-62-A.



AL-62-A

AL-63-A

Snap hook on one ribbon end
and another on spool, adapts
ribbon at desired length.

CHAIN DELINEATORS

Reference				Description	
	mm	mm	mm		g
AL-31/05	5 m	8	70 x 27	Red & white	550
AL-31/25	25 m	8	70 x 27	Red & white	3750
AL-32/05	5 m	8	70 x 27	Black & yellow	550
AL-32/25	25 m	8	70 x 27	Black & yellow	3750
AL-31	-	6.5	52 x 30	Set of 10 opening links red & white.	55

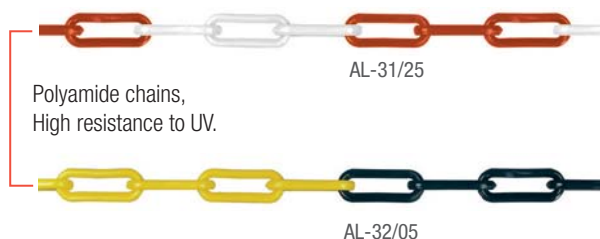

AL-31/25

AL-32/05

Polyamide chains,
High resistance to UV.

LV Test and measurement



Voltage Detector	94
Safety test probes and accessories	99
Phase rotation indicator	100
Safety test probes and accessories	101
Installation Controller	102
Accessories	104





DETEX™ 917-L AND 918-L VOLTAGE DETECTORS AND TESTERS

The **Detex™ MS-917-L** and **918-L** are designed based on the **IEC 61243-3** standard, in response to the requirements of the **EN 50110-1** European standard. Sound and lighting equipment, suitable for indoor/ outdoor use. It enables to detect absence of voltage and :

- Checks voltage levels from 12 to 690V AC, 750V DC (MS 917-L) and from 12 to 900V AC, 1000V DC (MS 918-L).
- Sound and light continuity for a non-live circuit (threshold of 200 Ω for 917-L and 100 Ω for 918-L),
- Unipolar identification of the phase,
- Search for the polarities of a DC circuit,
- Rotary Field by the two-wire method only for 918-L.

Detex™+ MS-917-L

IEC 61243-3
EN 61243-3



MS-917-L
MS-918-L

The configuration with both fixed points allows for a 19 mm gap between points, which immediately normalizes the double contact (2P+T, 10/16 A).



THE ⊕

MS 917-L et MS 918-L

- 1 Test-lead points. Point Ø 2 mm and 19 mm lengths for well contact
- 2 Hazardous voltage indicator light (> 50 V).
- 3 Phase identification light (unipolar).
- 4 Test button.
- 5 Completely modular and adjustable using type E plugs.

MS 918-L

- 6 Lighting unit.
- 7 Phase rotation detection check (two-wire method).
- 8 Voltage light for 12 to 900 V AC (1000 DC).



Detex™+ MS-918-L

Phase identification light (unipolar).



8 Voltage light. for 24 to 690 V AC (750 DC)

Multifunctional light
12 V / + range
12 V / - range

7 Phase rotation detection check (two-wire method)

Hazardous voltage light (> 50 V).



MS-918-L storage configuration.



M-87369 Carrying bag.



M-952325 Board hanger provided on the back of the device.

Accessories

Reference	Characteristics
M-87369	Carrying bag *
M-952325	Board hanger *

* Ordered separately.

Selections and Characteristics:

Reference												
	Voltage	50/60 Hz +/- 10 %	Continuity	IP65 Protection IK06	Class II	Category IV 600 V	Operations -15 to +45 °C (class N)	2 AAA batteries 1.5 V	Rotary Field	Suitable for standard 2P+T, 19 mm	Lighting unit.	210
MS-917-L *	690	•	200	•	•	•	•	•		•		•
MS-918-L *	900	•	100	•	•	•	•	•	•	•	•	•

* Supplied without accessories.





DETEX™ 920-EX VOLTAGE DETECTOR AND TESTER

The **Detex™ MS-920-EX** is designed based on IEC 61243-3 standard, in response to the requirements of the EN 50110-1 European standard.

Sound and lighting equipment, suitable for indoor/ outdoor use. It enables to detect absence of voltage and :

- Check of voltage levels > 50 V DC and AC,
- Up to 690 V AC and 800 DC,
- Continuity sound control for a non-live circuit (< 100 Ω),
- Unipolar identification of the phase,
- Search for the polarities of a DC circuit,
- Rotary field by the two-wire method.
- Resolution : 1 V
- Precision : ± 5 %

Detex™ +

MS-920

IEC 61243-3 / EN 61243-3
EN 61010-1



THE

- 1 Test-lead points according to IEC 61010-031 Point Ø 2 mm and 19 mm lengths for well contact.
- 2 Three digit colour LCD screen display.
- 3 Test button.
- 4 Indicator light when voltage > 50 V.
- 5 Completely modular and adjustable using type E plugs.
- 6 Lighting unit.

The configuration with both fixed points allows for a 19 mm gap between points, which immediately normalizes the double contact (2P+T, 10/16 A).





Example of continued 24 V detection, display is **BLUE** because < 50 V.

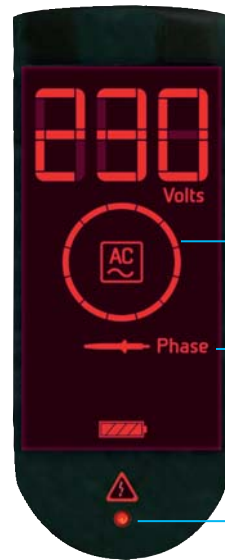

Example of detecting 230 V AC, displayed in **RED**.

Rotary Field indicator.

Unipolar identification of the phase.

4 Hazardous voltage indicator light (> 50 V).

Polarity.



6



MS-920-EX storage configuration.



M-87369 Carrying bag.



M-952325 Board hanger provided on the back of the device.

Accessories

Reference	Characteristics
M-87369	Carrying bag *
M-952325	Board hanger **

* Ordered separately.

Selections and Characteristics:

Reference													
	Voltage 12-690 V AC 12-800 V AC	50/60 Hz	Continuity < 100 Ω	IP65 Protection IK06	Class II	Category IV 600 V	-15 to +55°C (class N)	Display 3 digits	2 AAA batteries 1.5 V	Rotary Field	Suitable for standard 2P+T, 19 mm	Lighting unit.	210
MS-920-EX *	•	•	200	•	•	•	•	•	•	•	•	•	

* Unit comes with a hook table.



NO VOLTAGE TESTER FOR ELECTRIC VEHICLES

EN 61243-3 (2010) /
IEC 61243-3 (2009)
CE

The **MS-917-VE NVT** voltage tester was specially designed to check for no voltage and direct current voltages on electric or hybrid vehicles.

Used for No Voltage Checks and also:

- checking voltage levels from 12 to 700 V DC,
- checking a circuit's sound and light continuity (power off),
- searching for polarity in a DC circuit.

Do not leave on for more than 30 s.



THE

- 1 IP2X test-lead points retractable sleeves. New: the "Touch" function: hold in the retracted position in complete safety.
- 2 Test button and continuity control.



Voltage detection on electrical power circuit.

Selections and characteristics:

Reference					IV					
	Voltage	Continuity	Protection IP65 IK06	Class II	Category IV 600 V	-15 to +45°C (class N)	2 AAA batteries 1.5 V	Phase rotation direction	Suitable for standard 2P+T. 19 mm	Lighting unit. 210
MS-917-VE	12-700 V DC	•	•	•	•	•	•	•	•	•

* Unit comes with a hook table.

CONTACT PROBES FOR L.V. TESTER

Light and rigid contact antennas for Detex™ : MS-917-L, MS-918-L and MS-920-EX. Contact antennas used as suspension hooks. Round tip contact.

For installations and sidewalk boxes

Reference	↔	kg
MS-8013-2	50 cm	0.40

Delivered in storage bag 50 x 130 x 470 mm.

For overhead lines

Reference	↔	kg
MS-8014-2	125 cm	0.75

Delivered in storage bag 50 x 130 x 470 mm.



HAND STICK

For distance working 2 removable elements. Field of use: 1 000 V max. Ergonomic handle. Connecting test probe by standard socket.

Reference	Characteristics	↔	kg
M-951143	Hand stick	80 cm	0.24
M-952439	Extension	40 cm	0.12

Delivered in storage bag.



STORAGE BAG

Reference	mm	Characteristics
M-87369	180 x 70 x 45	Storage bag with seatbelt for MS-917, MS-920.
M-87290	200 x 120 x 50	Storage bag with stray for MS-152+ et MS-703.



M-87369



M-87290



Weight ↔ Total length



PHASE ROTATION INDICATOR DETEX™ MS-152 +

IEC 61557-7
CE

Signaling via the successive lighting of diodes symbolising rotation.

"FAULT" diode lites: phase cut off or incorrectly connected. Phase rotation activated ≥ 85 V.

A set of diodes is turned on and off successively
The diodes indicate:

- Clockwise rotation indicated by the green arrow "OK",
- Anti-clockwise rotation indicated by the red arrow "INVERSE",
- Fault: the DEFECT diode (DEFAULT) indicates an error of connection such as the cut or absence of phase or the presence of neutral between phases

Probes with retractable protector with 1.20 flexible cable.

GREEN - CX-35811.

YELLOW - CX-45411.

BROWN - CX-34211.

Isolated crocodile clamp IP2X :

YELLOW - CX-01422.

BROWN - CX-01222.

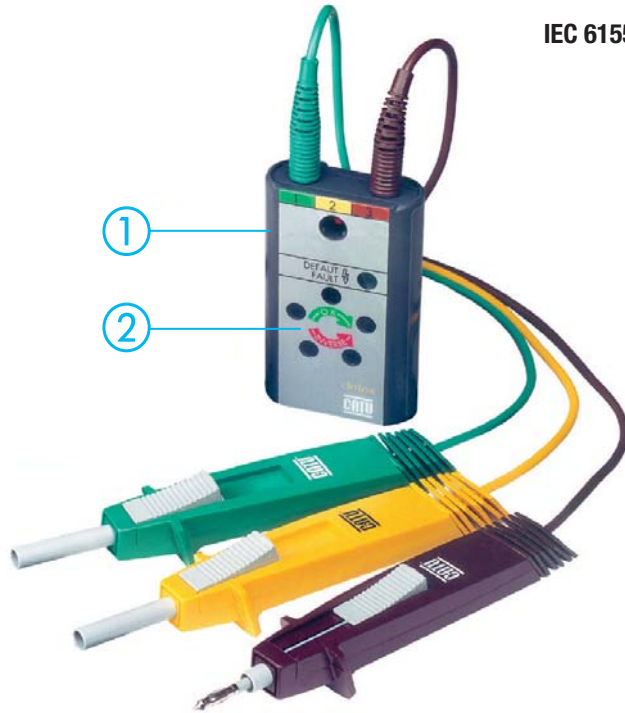

Rotate right

Rotate left

Default

THE

- 1 Compact.
- 2 Visualization by rotation LED's circle.
- 3 Works on generating units.

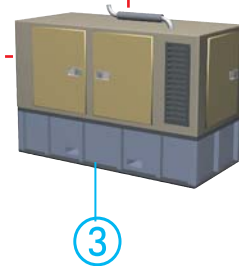

Accessories

Reference	Characteristics
M-87290	Carrying bag with stray. (included)



Carrying bag
with stray.

M-87290

Selections and characteristics:



Reference				IV				
MS-152-X	Voltage 90-400 V	45/60 Hz	Protection IP54 IK06	Class III IEC 61010-1	Phase rotation direction	IP2X test-lead points. IEC 61010-31	225x130x65 = storage	100

* Delivered in storage bag with 3 probes (GREEN, YELLOW, BROWN) 2 crocodile clamps (YELLOW BROWN).

VOLTAGE TAKE-OFF PUNCH

The voltage take-off punch is able to make an insulating piercing on a low voltage wire to plug a measurement device. Steel pin. Isolated body. Female socket for safety test probe \varnothing 4 mm.



Reference	 mm	 g
MS-62	\varnothing 0.6 - 14.4	15
MS-63	\varnothing 12 - 31	5



Railways

Electrical safety equipment





GROUNDING AND CONTINUITY MEASUREMENT DEVICE CATO^{HM}™ DT-300

IEC 61010-1
NF EN 61557-4
CE

CATO^{HM}™ DT-300 is designed based on the IEC 61557-4 standard.

The device measures ground resistance using the "default loop" principle.

The **CATO^{HM}™ DT-300** shows the following on its LCD display:

- The presence of voltage and compliance,
- The position of the phase,
- The grounding of the production conductor, the main functions being to measure the ground resistance value and to thus check the continuity of metal masses by sound signal.

Once connected to properly connected installation, the grounding value is instantly measured and displayed at the top of the LCD display, indicating ground resistance values:

- **0 to 100 Ω**, **BLUE** numbers (< the 100 threshold Ω)
- **101 to 999 Ω**, **RED** digits

The measurement is taken with an accuracy of +/- 3 % + 1 digit for pure resistance, ranging 0-200 Ω, at 23°C +/- 5°C.

Uses 2P+T 10/16 A or LV table for single-phase 230V circuits between phases and neutral. IP2X connection wells from the test-lead point. 4-digit display of the grounding value in Ω. Anti-skid clothing. Continuity extended 7 m along the roller (Ø 105 x H 62 mm). IP2X test-lead point with retractable sheathing. Checks the continuity of metal masses.



Example measurement without grounding, displayed in **RED**.



Check 2P+T outlet with test-lead point on extension.

Accessories

Reference	Characteristics
M-921647	Roller with 7 m of cord *
M-87292	Storage bag

* To be ordered separately.



Grounding value < 100Ω.



Connection between phases under 400V.



Grounding value > 100Ω.

THE ⊕

- 1 Full autonomy (without battery).
- 2 Use on 2P+T outlet or on LV table with cord.
- 3 LCD display instantly displays the interpretation of measures in terms of their conformity.
- 4 Measures the grounding loop without tripping the breakers: < 15 mA.
- 5 Non-slip coating for a better grip.
- 6 7 m continuity extension cord.

Features:

Reference												
DT-300 *	230V voltage TT schema	50/60 Hz	Continuity measured at ≤ 2 Ω	400 V voltage present	IP40 Protection IK06	Class II	Category III 600V	Use: -15 °C to +45 °C	4-digit screen display	Grounding < 2000 Ω	71x210x51	0.36

* Controller delivered with probes and extension on roller.

INSULATION CONTROLLER CATEX™

IEC 60364 standard recommends periodically checking insulation resistance. Insulation resistance is measured between each active conductor and the ground (when not live). Its value should be 500 kΩ for a DC testing voltage of 500 V.

The DT-500 is a specially designed device for quickly, easily, and safely measuring insulation resistance.

It provides a safety system that prevents a measurement when connected to a live installation.

Measures insulation resistance below 500 V.

The insulation resistance value is indicated by illuminating a light:

- **RED** for values including 0, 300, 400 kΩ.
- **GREEN** for values including 500, 600, 700, 800, 900, 1 000 k and kΩ et ∞.

IP2X test-lead point **YELLOW/GREEN** (ground).

3 large opening alligator clips:

RED, YELLOW/GREEN, BLUE.

IEC 61010-1
EN 61557-2
CE



PICTURE OF INSTALLATION WITHOUT PRESENCE VOLTAGE.



THE

- 1 Battery status indicator light.
- 2 IP2X test-lead point BLUE (neutral) independent and connected by a safety terminal.
- 3 The DT-500 can bypass the phase and neutral in order to protect sensitive equipment (electronics, computers, etc.).
- 4 The DT-500 comes with a belt clip and areas where test-lead points can be stored.

Accessories

Reference	Characteristics
M-951981	BLUE probe for replacement *
M-87292	Carrying bag *
M-881602	BLUE alligator clip for replacement
M-881601	YELLOW/GREEN alligator clip for replacement

* To be ordered separately.

Features:

Reference	500 V DC	mesures				Use: 15 °C to +45 °C	4 LR6 batteries	IP2X test-end points	213 x 75 x 46 mm	600 with batteries and accessories
DT-500 *	Output voltage < 500 V DC	from 0 to ∞	IP54 Protection IK06	Class II	Category III 600V	Use: 15 °C to +45 °C	4 LR6 batteries	IP2X test-end points	213 x 75 x 46 mm	600 with batteries and accessories

* Controller delivered with 3 probes, 3 alligators clips and batteries.

Dimensions

Masse





LEAD SET FOR CHECKS ON L.V DISTRIBUTION BOARD

Heartbring safety crocodile clamp. Safety test probes with retractables sheath. Female socket Standard 2P+T.

Reference	Characteristics
M-952271	Lead set for checks on L.V distribution board * Lg 0.80 cm

* For DT-300 and DT-170 only.



STORAGE BAG

Reference	mm	Characteristics
M-87292	250 x 200 x 70	Flexible storage bag with handle.



RANGE OF TESTERS FOR LAW VOLTAGE

CP-100-C
CONTINUITY TESTER



CP-100-B
CONTINUITY TESTER
AND MAIN UNIT



MX-702
DIGITAL CLAMP
MULTIMETER



MX-704
INFRARED
THERMOMETER



MX-701
DIGITAL
MULTIMETER

For more informations, consult us.

LV earthing systems



Overhead bare	106
Overhead insulating	108
LV Cabinets	109



SHORT-CIRCUITING SYSTEMS

Set of 4, 5, 6 or 7 clamps MT-411.

An extra-flexible 16 mm² copper cable assembly.

An insulated socket that can be locked with a bayonet, for connecting a grounded system.

Telescopic stick 2 m CE-2-21-C.

Waterproof bag MT-400-01.

Reference	Composition	kg
MT-404	3 MT-411 + 1 MT-411-C	3.4
MT-405	4 MT-411 + 1 MT-411-C	3.8
MT-406	5 MT-411 + 1 MT-411-C	4.2
MT-407	6 MT-411 + 1 MT-411-C	4.6



icc : 3 kA/1s



EARTHING EQUIPMENT FOR OVERHEAD LINES SYSTEMS

Grounding device connecting with the earth rod MT-650.

Insulated pin connecting to a short circuit socket.

Référence	⊗ m x mm ²	Earth Clamp	kg
MT-242	2 x 16	MT-840/1	1
MT-244	10 x 10	MT-840	2.5
MT-245	10 x 16	MT-840/1	3
MT-249	15 x 16	MT-840/1	3.8

Packaging: polypropylene case 310 x 280 x 105 mm.



SHORT-CIRCUITING AND EARTHING SYSTEMS NEVERS ERDF TYPE

Short-circuit ERDF networks for the work of pruning trees.

Implementation from the ground up to 10.5 m (sticks + operator) without climbing the support.

Insulating stick made of resin polyester/ glass fiber tube diameter 36.

Reference	Composition	kg
MT-509/3	3 Telescopic metallic sticks 3 elements L = 2.37/6.15 m + 1 Telescopic metallic stick 3 elements (the last one insulating yellow) L = 2.37/6.15 m + 1 insulating stick 2 elements L = 1.65/3.3 m + 1 multi-strand of 4 cables L = 6 x 16 mm 2 with 2 female sockets + 1 stick raise-up + 1 stick support	19 (3 bags) mm²
MT-509/3EP	1 Telescopic metallic stick 3 elements L = 2.37/6.15 m + 1 cable L = 6 x 16 mm 2 with male socket	2.3
MT-509/3VAT	1 Telescopic metallic stick 3 elements (the last one insulating yellow) L = 2.37/6.15 m	2.5

Equipment packed in carrying bags.

Reference	Description	kg
CC-127-ERDF-C	Specific voltage detector Range : 127-400 V	0.45

Accessories :

Reference	Description
M952567	Multi strand of 5 copper cables
M952570	Insulating sticks support
MT-546	Insulating sticks raise up
M611386	Raise up sticks
M952568	Earth cable

Voltage detector
CC-127-ERDF-C.

IEC 61230

Earth cable
M952568.

Multi strand of 5 copper cables
M952567.

Insulating sticks
raise up MT-546.

Insulating sticks support
M952570.



Insulating sticks Nevers type.

Insulating sticks.

Insulating sticks bag.



LOWLOCK SYSTEM

For conductors 3 to 21 mm Ø.

With clamps type "snap-on/screw-on".

Connecting cables: 35 mm² copper.

Short-circuiting and earthing systems.

Reference	Rating	Composition	kg
MT-615/1-7.5	7.5	5 MT-616/1-03 contact clamps on handles (l = 0.35 m each) 4 braids of M-24-35 copper cable (1.00 m) 1 M-87-153 carrying bag 250 x 85 x 750 mm	3
MT-615/2-7.5	7.5	5 MT-616/1-03 contact clamps on handles 4 braids of M-24-35 copper cable (1.00 m) 1 braid of M-24-35 copper cable (7.00 m) 1 MT-840/1 earth clamp	6.5

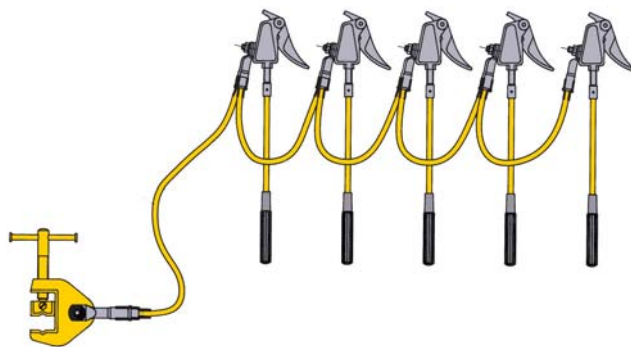

SHORT-CIRCUITING SYSTEMS

Equipment includes either 5 or 6 copper-aluminium alloy stubs.

Connector for conductor MT-222 or MT-223, see below, to be ordered separately.

Set of 4, 5, 6 or 7 clamps.

An extra-flexible 16 mm² copper cable assembly.

Reference	Socket	kg
MT-205	5	1.1
MT-206	6	1.5
MT-207	7	1.9

Packaging : polypropylene case 234 x 215 x 75 mm.

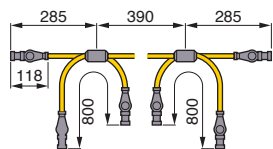

Connectors for conductors :

Reference	m x mm ²
MT-222	16 x 25
MT-223	35 x 70



Icc: 4 kA/1s

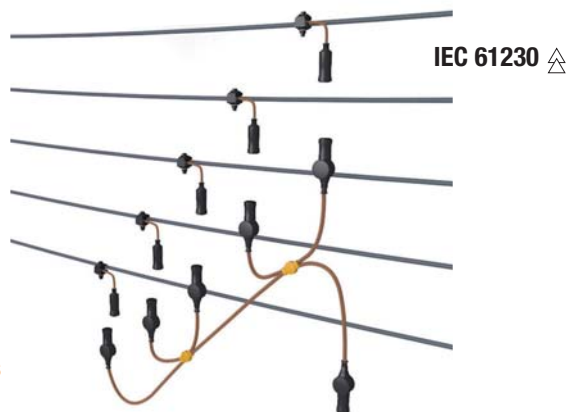

EARTHING EQUIPMENT

Earth rod.

Earthing equipment with bayonet splicing for overhead lines systems.

Galvanized steel. Hexagonal 18 mm per side.

Reference	↔	kg
MT-650	1 m	2.2

To be ordered in addition to short circuit and grounding equipment.



SHORT CIRCUITING DEVICE FOR LV CABINET

The earthing works is a mandatory operation in the NFC 18510 (chp 7.1 - Processes log) standard. Tinned copper insulated cable silicone core 16 mm². Authorized employment ERDF equipment.

Composition A: for connection.

Composition B: for network.

Composition C: for connection and network.
Maximum Icc: 4kA/1s

IEC 61230 



Reference	Composition
MC-296-A	4 multi-strand copper cables 16mm ² MC-296-440 + 1 micro clamps MC-296-P* + 1 connecting blade M-95627/4* + 1 round cartridge M-95626/4* + 1 cartridge size 00 MC-296-00/08* + 1 open end spanners 13/14/16/17 MO-687-D + 1 handle MC-296-M + 1 Case with foam and notice M-91209
MC-296-B	4 multi-strand copper cables 16mm ² MC-296-440 + 5 multi-strand copper cables 16mm ² M-952656 + 1 micro clamps MC-296-P* + 1 cartridge size 115 MC-296-115/08* + 1 cartridge size 160 MC-296-160/08* + 1 threaded adapters MC-181* + 1 pipe wrench 10x17mm M-882462 + 1 open end spanners 13/14/16/17 MO-687-D + 1 handle MC-296-M + 1 case with foam and notice M-91209
MC-296-C	4 multi-strand copper cables 16mm ² MC-296-560 + 5 multi-strand copper cables 16mm ² M-952656 + 5 micro clamps + 1 connecting blade M-95627/4* + 1 round cartridge M-95626/4* + 1 cartridge size 00 MC-296-00/08* + 1 cartridge size 115 MC-296-115/08* + 1 cartridge size 160 MC-296-160/08* + 1 threaded adapters MC-181* + 1 pipe wrench 10x17mm M-882462 + 1 open end spanners 13/14/16/17 MO-687-D + 1 handle MC-296-M + 1 case with foam and notice M-91209

* Sold in packs of 4.
Other composition on request.



Intervention :
On LV Cabinets.

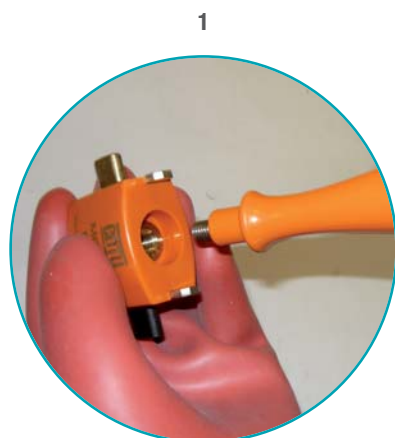

SHORT CIRCUITING DEVICE FOR LV INDUSTRIES CABINET

Icc : 4 kA/1s

IEC 61230 

The earthing works is a mandatory operation in the NFC 18510 (- Processes log chp 7.1) standard.

Multi strand isolated copper silicon cable 16 mm².

Reference	Composition
MC-296-NFC	5 multi-strand copper cables 16mm ² M-952650 + 5 micro clamps + 1 Case and notice M-76768

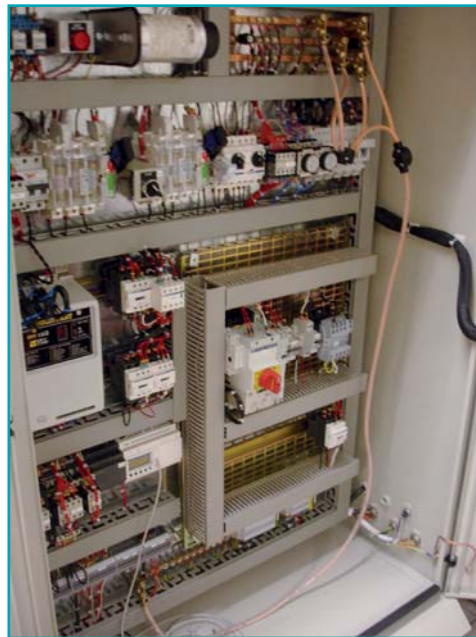

Threaded adapter

Smooth threaded terminals for positioning shunts (live working tools) or earthing equipment and short circuit cabinets terminals LV.

Reference	Description	Composition	
MC-184-6F	Smooth threaded terminal M6	Set of 4 adapters by reference, delivered in a vinyl bag	0.12
MC-182	Smooth threaded terminal M8	Set of 4 adapters by reference, delivered in a vinyl bag	0.15
MC-185-10F	Smooth threaded terminal M10	Set of 4 adapters by reference, delivered in a vinyl bag	0.20
MC-183	Smooth threaded terminal M12	Set of 4 adapters by reference, delivered in a vinyl bag	0.25



Reference	Description	Composition	
MC-184-6M	Smooth threaded terminal M6	Set of 4 adapters by reference, delivered in a vinyl bag	0.12
MC-182-8M	Smooth threaded terminal M8	Set of 4 adapters by reference, delivered in a vinyl bag	0.15
MC-185-10M	Smooth threaded terminal M10	Set of 4 adapters by reference, delivered in a vinyl bag	0.20
MC-181	Smooth threaded terminal M12	Set of 4 adapters by reference, delivered in a vinyl bag	0.25



LV Live working tools



Insulated tools	112
Jumper clamps, cables and accessories	144
Cable identifier	147





Find the tools to meet your needs!

Insulated tools must comply with the NF EN 60900 and IEC 60900 standards. To meet these standards, insulated tools undergo 10 000 volts through electrical testing and many mechanical tests, including impact tests, tearing tests, and puncture tests. For working live at nominal voltage up to 1000 V AC and 1500 V DC.



IEC 60900 2012



Test for adhesion of the insulating material

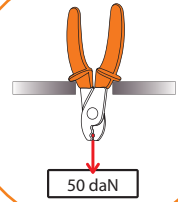

Impact Test

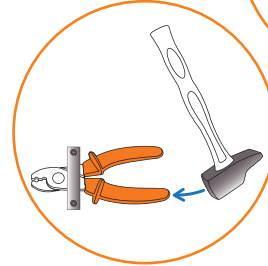

Flame retardancy

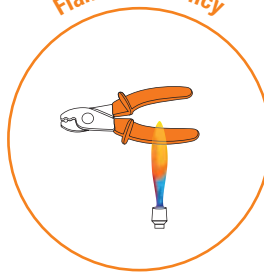

Dielectric Test

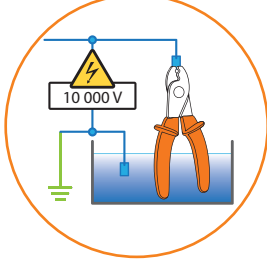

Indentation

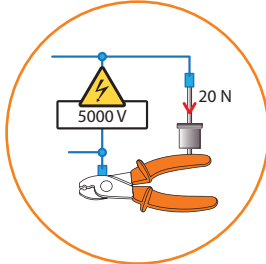

Dual Material Insulated Tools

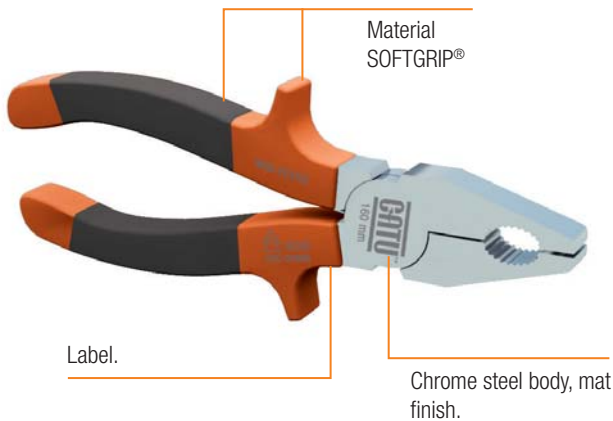

Dual Layer Insulated Tools

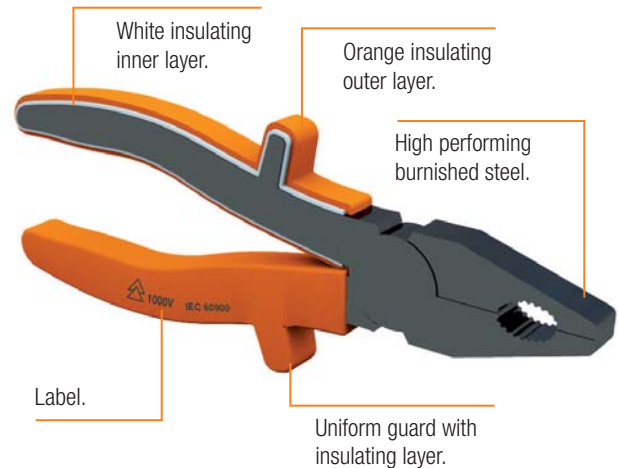

THE ⊕

- Products suitable for work on live cables, particularly low voltage (30 cm area of a live bare wire).
- Ergonomic.
- Dual material with non-skid "SOFTGRIP"® injected material for operator comfort.

THE ⊕



- Extensive product line for work on live cables; mainly used by LV Live Line Working teams.
- Ergonomic.
- Dual-layer with a white insulating layer.
- High mechanical strength in the layers due to dipping technique.
- Steel with high mechanical properties.

FLAT BLADE SCREWDRIVER, DUAL MATERIAL

IEC 60900 





Chrome - molybdenum vanadium steel blade.

Reference	∅ mm	 mm	 g
MO-72002	2.5	60	30
MO-72003	3	100	40
MO-72004	4	125	50
MO-72005	5	150	70
MO-72006	6	150	90
MO-72008	8	175	150
MO-72010	10	200	220



POZIDRIV SCREWDRIVER, DUAL MATERIAL



Dual material handle. Anti slip material. Chrome - molybdenum vanadium steel blade. Injection molded insulation.

Reference	PZ N°	 mm	 g
MO-72040	PZ 0	60	25
MO-72042	PZ 1	100	60
MO-72044	PZ 2	125	90
MO-72046	PZ 3	150	150
MO-72048	PZ 4	200	220



PHILLIPS SCREWDRIVER, DUAL MATERIAL



Chrome - molybdenum vanadium steel blade. Dual material handle. Anti slip material.

Reference	PH N°	 mm	 g
MO-72030	PH 0	60	25
MO-72032	PH 1	100	60
MO-72034	PH 2	125	90
MO-72036	PH 3	150	150
MO-72038	PH 4	200	220



TORX SCREWDRIVER, DUAL MATERIAL

Chrome - molybdenum vanadium steel blade. Dual material handle. Anti slip material.



Reference	N°	 mm	 g
MO-72056	T 6	50	25
MO-72057	T 7	50	25
MO-72058	T 8	50	25
MO-72059	T 9	75	35
MO-720510	T 10	75	35
MO-720515	T 15	75	50
MO-720520	T 20	100	70
MO-720525	T 25	100	80
MO-720527	T 27	115	90
MO-720530	T 30	125	100
MO-720540	T 40	125	120
MO-720545	T 45	150	160
MO-720550	T 50	175	200





HEXAGONAL SCREWDRIVER ALLEN, DUAL MATERIAL

Chrome - molybdenum vanadium steel blade. Dual material handle. Anti slip material.

Reference	On flats (mm)	 mm	 g
MO-68402	2.5	75	40
MO-68403	3	75	50
MO-68404	4	100	70
MO-68405	5	100	80
MO-68406	6	125	100
MO-68408	8	150	150



CABLE CUTTER PLIER, DUAL MATERIAL

Chrome-vanadium steel. Dual material handle. Anti slip material.

Reference	 mm	 mm Cu / Al	 kg
MO-72200	160	Ø 5 max	0.23



WIRE STRIPPING PLIER, DUAL MATERIAL







Chrome-vanadium steel. Dual material handle. Anti slip material.

Reference	 mm	 mm Cu / Al	 kg
MO-72172	160	0.5 to 10 mm ²	0.17



UNIVERSAL PLIER, DUAL MATERIAL

Chrome-vanadium steel. Dual material handle. Anti slip material.



Reference	 mm	 mm			 kg
		 Ø 3.5	 Ø 2.2	 Ø 1.5	
MO-72102	180	Ø 3.5	Ø 2.2	Ø 1.5	0.28



FLAT NOSE PLIER, DUAL MATERIAL

IEC 60900 







Chrome-vanadium steel. Dual material handle. Anti slip material.

Reference	 mm	 kg
MO-72132	160	0.17



BENT SNIPE NOSE PLIER, DUAL MATERIAL



Chrome-vanadium steel. Dual material handle. Anti slip material.

Reference	 mm	 mm			 kg
					
MO-72142	160	Ø 2.5	Ø 1.6	Ø 1	0.17



ROUND NOSE PLIER, DUAL MATERIAL

Chrome-vanadium steel. Dual material handle. Anti slip material.

Reference	 mm	 kg
MO-72122	160	0.16



WATER PUMP PLIER, DUAL MATERIAL







Chrome-vanadium steel. Double rack slipt joint. Dual material handle. Anti slip material.

Reference	 mm	 mm	 kg
MO-72155	250	32	0.35



SIDE CUTTER PLIER, DUAL MATERIAL

Chrome-vanadium steel. Dual material handle. Anti slip material.

Reference	 mm	 mm			 kg
					
MO-72162	160	Ø 3	Ø 2.2	Ø 1.5	0.21



 Total length

 Blade length

 Cutting capacity

 Stripping capacity

 Maximal opening

 Weight

● Steel: 75 daN / mm² ● Steel: 180 daN / mm² ● Steel: 220 daN / mm²

LV Live working tools / Insulated tools



SCREWDRIVERS KIT, DUAL MATERIAL

Reference	Composition
KIT-23	Flat blade screwdriver de 4 x 125 mm MO-72004 Flat blade screwdriver 6 x 150 mm MO-72006 Flat blade screwdriver 8 x 175 mm MO-72008 POZIDRIV screwdriver N°1 MO-72042 POZIDRIV screwdriver N°2 MO-72044



IEC 60900

PLIERS KIT, DUAL MATERIAL

Reference	Composition
KIT-27	Universal plier 180 mm MO-72102 Water pump plier 250 mm MO-72155 Wire stripping plier 160 mm MO-72172 Bent snipe nose plier 160 mm MO-72142 Cable cutter 160 mm MO-72200



INTERVENTION KIT, DUAL MATERIAL

Reference	Composition
KIT-24	Flat blade screwdriver 4 x 125 mm MO-72004 Flat blade screwdriver 6 x 150 mm MO-72006 Flat blade screwdriver 8 x 175 mm MO-72008 POZIDRIV screwdriver N°1 MO-72042 POZIDRIV screwdriver N°2 MO-72044 Wire stripping plier 160 mm MO-72172 Bent snipe nose plier 160 mm MO-72142 Cable cutter 160 mm MO-72200



COMPLETE INTERVENTION KIT, DUAL MATERIAL

Reference	Composition
KIT-25	Flat blade screwdriver 4 x 125 mm MO-72004 Flat blade screwdriver 6 x 150 mm MO-72006 Flat blade screwdriver 8 x 175 mm MO-72008 POZIDRIV screwdriver N°1 MO-72042 POZIDRIV screwdriver N°2 MO-72044 Universal plier 180 mm MO-72102 Water pump plier 250 mm MO-72155 Wire stripping plier 160 mm MO-72172 Bent snipe nose plier 160 mm MO-72142 Cable cutter 160 mm MO-72200



SCREWDRIVERS KIT DUAL MATERIAL

IEC 60900 



Photo of KIT-23SCP

	KIT-23C	KIT-23S	KIT-23SC2	KIT-23SH	KIT-23P	KIT-23SP2	KIT-23SCP	KIT-23CH	KIT-23PH
MO-72003 flat blade screwdriver 3 x 100		•	•	•		•	•		
MO-72004 flat blade screwdriver 4 x 125		•	•	•		•			
MO-72005 flat blade screwdriver 5 x 150		•	•	•		•	•		
MO-72006 flat blade screwdriver 6 x 150		•	•			•			
MO-72008 flat blade screwdriver 8 x 175		•							
MO-72030 screwdriver PH 0 x 60	•								
MO-72032 screwdriver PH 1 x 100	•		•				•	•	
MO-72034 screwdriver PH 2 x 125	•		•				•	•	
MO-72036 screwdriver PH 3 x 150	•							•	
MO-72040 screwdriver PZ 0 x 60					•				
MO-72042 screwdriver PZ 1 x 100					•	•	•		•
MO-72044 screwdriver PZ 2 x 125					•	•	•		•
MO-72046 screwdriver PZ 3 x 150					•				•
MO-68403 hexagonal screwdriver 3 x 75				•				•	•
MO-68404 hexagonal screwdriver 4 x 100				•				•	•
MO-68404 hexagonal screwdriver 5 x 100				•				•	•

Delivered under blister.





FLAT BLADE SCREWDRIVER

IEC 60900

Chrome - molybdenum vanadium steel blade.

Reference	∅ mm	 mm	 g
MO-65202	6.5	40	38
MO-65203	3	100	33
MO-65204	3.5	100	37
MO-65205	4	100	46
MO-65206	5.5	125	75
MO-65207	6.5	150	94
MO-65209	8	175	165
MO-65211	10	200	195
MO-650-D	Set of 3 screwdrivers MO-65205 / MO-65207 / MO-65209		
MO-652-D	Set of 4 screwdrivers MO-65203 / MO-65205 / MO-65207 / MO-65209		



FLAT BLADE SCREWDRIVER WITH RECESSED BLADE

Chrome - molybdenum vanadium steel blade.

Reference	∅ mm	 mm	 g
MO-65200D	6.5	40	36
MO-65202D	2	70	16
MO-65203D	3	100	30
MO-65204D	4	120	52
MO-65205D	5.5	100	50
MO-652055D	5.5	150	72
MO-65206D	6.5	150	36
MO-65208D	8	150	92
MO-652082D	8	200	142
MO-65210D	10	150	166
MO-652102D	10	250	282
MO-65212D	12	250	318



PHILLIPS SCREWDRIVER

Chrome - molybdenum vanadium steel blade.

Reference	∅ mm	 mm	 g
MO-65230	PH 0	60	25
MO-65232	PH 1	80	50
MO-65234	PH 2	100	75
MO-65236	PH 3	150	150
MO-65238	PH 4	200	230
MO-653-D	Set of 3 screwdrivers N°0, N°2 et N°3		



PHILLIPS SCREWDRIVER WITH RECESSED BLADE

Chrome - molybdenum vanadium steel blade.



Reference	∅ mm	 mm	 g
MO-65232D	PH 0 (4)	75	50
MO-652321D	PH 0 (4)	150	55
MO-65233D	PH 1 (5)	100	60
MO-65234D	PH 2 (6)	125	82
MO-65236D	PH 3 (8)	150	146
MO-65238D	PH 4 (10)	200	256



POZIDRIV SCREWDRIVER

IEC 60900 



Chrome - molybdenum vanadium steel blade..

Reference	PZ N°	 mm	 g
MO-65240	PZ 0	60	25
MO-65242	PZ 1	80	50
MO-65244	PZ 2	100	75
MO-65246	PZ 3	150	150
MO-65248	PZ 4	200	230



POZIDRIV SCREWDRIVER WITH RECESSED BLADE



Chrome - molybdenum vanadium steel blade.

Reference	 mm	 mm	 g
MO-652405D	5	40	34
MO-652406D	6	40	34
MO-65244D	PZ 0 (4)	75	50
MO-652441D	PZ 0 (4)	150	55
MO-65245D	PZ 1 (5)	100	60
MO-65246D	PZ 2 (6)	125	82
MO-65248D	PZ 3 (8)	150	146
MO-652410D	PZ 4 (10)	200	256



SCREWDRIVER BLOCK TERMINAL FLAT/PHILLIPS



Chrome - molybdenum vanadium steel blade.

Reference	 mm	 mm	 g
MO-65405	5	80	50
MO-65406	6	100	60



SCREWDRIVER BLOCK TERMINAL FLAT/POZIDRIV

Chrome - molybdenum vanadium steel blade.

Reference	 mm	 mm	 g
MO-65505	5	80	50
MO-65506	6	100	60



For fuse boxes, connecting boxes, circuit breaker terminal blocks.

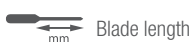



UNIVERSAL PLIER

Special steel, oil-hardened. Burnished head.

Reference	mm	kg
MO-66001	160	0.21
MO-66002	180	0.26
MO-66003	200	0.30
MO-66005	250	0.51



MO-66002

IEC 60900



MO-66005

FLAT NOSE PLIER

Chrome-vanadium steel.

Reference	mm	kg
MO-66300	145	0.11
MO-66301	160	0.16
MO-66302	170	0.18



BENT SNIPE NOSE PLIER

Chrome-vanadium steel.

Reference	mm	kg
MO-66402	160	0.16
MO-66404	200	0.18



ROUND NOSE PLIER

Chrome-vanadium steel.

Reference	mm	kg
MO-66202	160	0.15



LONG NOSE PLIER WITH SIDE CUTTER

Chrome-vanadium steel.

Referencia	mm	kg
MO-66102	160	0.14



PLUG PLIER FOR PREINSULATING PIN TERMINALS

Chrome-vanadium steel for pin terminals 2.8/5/6.35 mm.

Reference	mm	kg
MO-66105	210	0.20



INSULATING UNIVERSAL PLIER

Composite insulation. Entirely insulating.

Reference	mm	mm	kg
MO-66000C	200	16 mm ² copper	0.17



INSULATING FLAT NOSE PLIER

Composite insulation. Entirely insulating.

Reference	mm	mm	kg
MO-66303C	190	16 mm ² copper	0.11

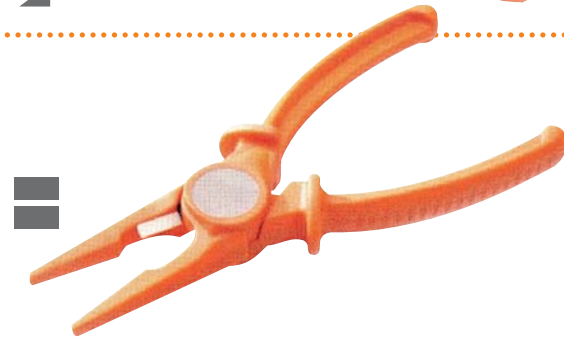

INSULATING BENT HALF ROUND NOSE PLIER

Composite insulation.

Reference	mm	mm	kg
MO-66404CC	210	16 mm ² copper	0.11



WATERPUMP PLIER

Chrome-vanadium steel.

Reference	mm	mm	kg
MO-66502	250	33	0.25
MO-66505*	250	33	0.40
MO-66500	410	45	1.00

* Double rack slip joint (MO-66505 only).



END CUTTING PLIERS

Chrome-vanadium steel.

Reference	mm	mm		kg
		mm	mm	
MO-67401	140	∅ 2	∅ 1	0.16
MO-67402	160	∅ 3	∅ 2	0.21
MO-67404	200	∅ 4	∅ 3	0.45



mm Total length mm Maximal opening mm Cutting capacity

kg Weight

● Steel: 75 daN / mm² ● Steel: 180 daN / mm² ● Steel: 220 daN / mm²



DIAGONAL CUTTING PLIER

IEC 60900

Chrome-vanadium steel.

Reference	mm	mm			kg
MO-67101	140	Ø 2	Ø 1	Ø 0.5	0.15
MO-67102	160	Ø 3	Ø 2.2	Ø 1.5	0.18
MO-67103	190	Ø 3.2	Ø 2.5	Ø 2	0.21



CABLE CUTTER

Chrome-vanadium steel.

Reference	mm	mm	kg
MO-67500	180	Ø 5 Cu / Al	0.42



CABLE CUTTER

Chrome-vanadium steel.

Reference	mm	mm	kg
MO-67501	170	Ø 15	0.28
MO-67502	230	Ø 20	0.52



CABLE CUTTER

Chrome-vanadium steel.

Reference	mm	mm	mm	é mm
MO-67700	590	30	185 mm ² Copper/ Aluminium	2.5
MO-67701	765	20	Ø 12 Alu	2.8



WIRE STRIPPING PLIER

Chrome-vanadium steel.

IEC 60900 

Reference	 mm	 mm Stripping capacity mm ²	 kg
MO-67302	160	from 0.5 to 10 mm ²	0.17



WIRE STRIPPING PLIER FULLY INSULATED

Reference	 mm	 mm Stripping capacity mm ²	 kg
MO-67302C	175	from 0.5 to 10 mm ²	0.26



STRIPPING TOOL FOR LV CABLES



Aluminium casting plier.

Reference	 mm	 mm Stripping capacity	Section mm ²	 kg
MO-67304	220	Ø 8 to 21	16 to 150	0.47



STRIPPING TOOL FOR LV CABLES



Aluminium casting plier.

Reference	 mm	 mm Stripping capacity	Section mm ²	 kg
MO-67305	265	Ø 21 to 35	16 to 150	0.65
MO-67306	270	Ø 26 to 52	50 to 250	0.67



INSULATED KNIFE

Curved blade.

Reference	 mm	 mm	 kg
MO-61001	180	62	0.11
MO-61002	180	50	0.11

Delivered with pouch.



MO-61001



MO-61002

 Total length

 Cutting capacity

 Thickness

 Stripping capacity

 Maximal opening

 Weight

 Steel: 75 daN / mm²  Steel: 180 daN / mm²  Steel: 220 daN / mm²

LV Live working tools / Insulated tools





RATCHET CABLE CUTTER

IEC 60900

Treated forged steel blade.

Reference	mm	Copper section mm ²	Aluminium section mm ²	kg
MO-67599	Ø 32 max	260	320	0.90
MO-67600	Ø 38 max	300	350	0.95
MO-67601	Ø 55 max	400	450	0.97



MO-67599



MO-67600

FRONTAL RATCHET CABLE CUTTER

Treated forged steel blade.

Reference	mm	Copper section mm ²	Aluminium section mm ²	kg
MO-67611	Ø 32 max	180	250	0.90



HACKSAW

Protected hard forged steel. Two blade positions. Flush and 90° cutting supplied. Tension blade by screw.

Reference	mm	mm	kg
MO-64501	263	130	0.15
MO-64502*	450	300	0.78

* Delivered with 2 blades.





MO-64502



MO-64501

IEC 60900 



ADJUSTABLE SPANNER

Reference	 mm	 mm	 kg
MO-69002	210	24 max	0.29
MO-69003	250	28 max	0.45
MO-69004	310	34 max	0.55
MO-69005	385	43 max	1.35



REVERSIBLE RATCHET RING SPANNER

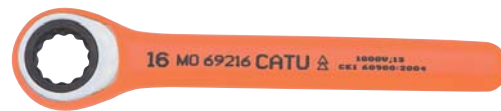

Special steel, oil-hardened.

Reference	 mm	 daN	 kg
MO-69210	10	5	0.16
MO-69213	13	9.5	0.19
MO-69216	16	16	0.35
MO-69217	17	18.5	0.37
MO-69218	18	20.5	0.38
MO-69219	19	24	0.39





COMBINATION WRENCH

Special steel insulated inserts using one-piece injection.

Reference	 mm	 mm	 kg
MO-68701	150 x 150	6-8-10-12	0.22
MO-68702	150 x 150	8-10-12-14	0.26
MO-68703	150 x 150	7-9-11-13	0.25
MO-68704	150 x 150	8-10-13-17	0.25
MO-68705	150 x 150	14-17-18-21	0.40



RIGHT ANGLE MALE HEXAGONAL KEY

Reference	 mm	 mm	 g
MO-69903	83 x 123	3	30
MO-69904	84 x 124	4	40
MO-69905	85 x 125	5	50
MO-69906	85 x 125	6	70
MO-69908	86 x 126	8	110
MO-69910	88 x 128	10	150
MO-69912	90 x 130	12	240



 mm Total length

 mm Blade length

 Weight

 daN Deca-newton

 On flats

 mm Maximal opening

 mm Cutting capacity

 mm Diameter

LV Live working tools / Insulated tools

CATUTM

#125



OPEN JAW SPANNER

IEC 60900

Reference	mm	g	Reference	mm	kg
MO-68006	6	20	MO-68019	19	0.17
MO-68007	7	20	MO-68020	20	0.18
MO-68008	8	40	MO-68021	21	0.20
MO-68009	9	40	MO-68022	22	0.22
MO-68010	10	45	MO-68023	23	0.25
MO-68011	11	50	MO-68024	24	0.26
MO-68012	12	60	MO-68025	25	0.28
MO-68013	13	80	MO-68026	26	0.30
MO-68014	14	100	MO-68027	27	0.34
MO-68015	15	110	MO-68028	28	0.36
MO-68016	16	120	MO-68029	29	0.40
MO-68017	17	140	MO-68030	30	0.50
MO-68018	18	160	MO-68032	32	0.57
MO-68008/19	8 open end spanners set: 8/10/11/12/13/14/17/19 mm				0.68



CRANKED RING SPANNER

Reference	mm	g	Reference	mm	kg
MO-68106	6	30	MO-68119	19	0.20
MO-68107	7	35	MO-68120	20	0.24
MO-68108	8	40	MO-68121	21	0.26
MO-68109	9	45	MO-68122	22	0.26
MO-68110	10	50	MO-68123	23	0.27
MO-68111	11	65	MO-68124	24	0.28
MO-68112	12	80	MO-68125	25	0.30
MO-68113	13	100	MO-68126	26	0.36
MO-68114	14	120	MO-68127	27	0.40
MO-68115	15	150	MO-68128	28	0.44
MO-68116	16	180	MO-68129	29	0.48
MO-68117	17	190	MO-68130	30	0.50
MO-68118	18	195	MO-68132	32	0.54





PIPE WRENCH

Reference	Socket head	mm	g	Reference	Socket head	mm	kg
MO-68205	6 sided	5	20	MO-682181	12 sided	18	0.33
MO-68206	6 sided	6	30	MO-682191	12 sided	19	0.43
MO-68207	6 sided	7	35	MO-682211	12 sided	21	0.50
MO-68208	6 sided	8	45	MO-682221	12 sided	22	0.63
MO-68209	6 sided	9	60	MO-682231	12 sided	23	0.68
MO-682101	12 sided	10	85	MO-68224	12 sided	24	0.73
MO-682111	12 sided	11	100	MO-68226	12 sided	26	0.81
MO-682121	12 sided	12	130	MO-68227	12 sided	27	1.00
MO-682131	12 sided	13	160	MO-68228	12 sided	28	1.08
MO-682141	12 sided	14	185	MO-68229	12 sided	29	1.13
MO-682151	12 sided	15	220	MO-68230	12 sided	30	1.31
MO-682161	12 sided	16	230	MO-68232	12 sided	32	1.55
MO-682171	12 sided	17	285				





IEC 60900 

HEXAGONAL SPANNER WITH T HANDLE, LENGTH 130 mm

Reference	 mm	 mm	 kg
MO-68610	135	10	0.14
MO-68613	135	13	0.2
MO-68614	135	14	0.25
MO-68620	135	20	0.35
MO-68621	135	21	0.37







HEXAGONAL SPANNER WITH T HANDLE, LENGTH 300 AND 400 mm

Reference	 mm	 mm	 kg
MO-68310	305	10	0.35
MO-68311	305	11	0.36
MO-68312	305	12	0.37
MO-68313	305	13	0.40
MO-68314	305	14	0.45
MO-68316	305	16	0.56
MO-68317	305	17	0.65
MO-68319	305	19	0.75
MO-68321	305	21	0.80
MO-68322	305	22	0.85
MO-68713	405	13	0.65
MO-68714	405	14	0.80
MO-68717	405	17	0.90
MO-68719	405	19	1.00
MO-68721	405	21	1.20



6 SIDED FEMALE SOCKET 3/8" (9.53 mm) SQUARE DRIVE LONG SERIES

Chrome steel. L: 65 mm.

Reference	 mm	 g	Reference	 mm	 kg
MO-69608	8	55	MO-69616	16	0.13
MO-69609	9	65	MO-69617	17	0.14
MO-69610	10	75	MO-69618	18	0.16
MO-69611	11	85	MO-69619	19	0.18
MO-69612	12	95	MO-69621	21	0.20
MO-69613	13	100	MO-69622	22	0.22
MO-69614	14	115	MO-69623*	23	0.23
MO-69615	15	120	MO-69624	24	0.24

* the dimensions 23 and 24 have 12 sides.



 Maximal opening

 Total length

 Weight

 On flats

 Diameter

LV Live working tools / Insulated tools

CATUTM

#127



6 SIDED FEMALE SOCKET 3/8" (9.53 mm) SQUARE DRIVE - METRIC AND U.S STANDARD

IEC 60900

Reference	mm	g	Reference	Inch	kg
MO-69306	6	25	MO-69323*	23	0.10
MO-69307	7	30	MO-69324*	24	0.12
MO-69308	8	30	MO-697-1/4SAE	1/4	0.25
MO-69309	9	30	MO-697-5/16	5/16	0.30
MO-69310	10	35	MO-69735	3/8	0.30
MO-69311	11	35	MO-69736	7/16	0.35
MO-69312	12	35	MO-69737	1/2	0.40
MO-69313	13	45	MO-69738	9/16	0.45
MO-69314	14	45	MO-69739	5/8	0.55
MO-69315	15	50	MO-69740	11/16	0.60
MO-69316	16	55	MO-69741	3/4	0.70
MO-69317	17	60	MO-69742	13/16	0.85
MO-69318	18	65	MO-697-7/8	7/8	0.90
MO-69319	19	70	MO-697-15/16*	15/16	0.10
MO-69321	21	85	MO-697-1SAE*	1	0.11
MO-69322	22	90			

*12 sided



6 SIDED MALE HEX KEY / SOCKET 3/8" SQUARE DRIVE

Reference	mm Male	g
MO-69393	3	16
MO-69394	4	18
MO-69395	5	20
MO-69396	6	22
MO-69397	7	24
MO-69398	8	25
MO-693100	10	35



MALE TORX 3/8" SQUARE DRIVE

Reference	mm	mm	g
MO-69T15	60	TX15 ★	50
MO-69T20	60	TX20 ★	55
MO-69T30	105	TR30 ★	60
MO-69T40	105	TR40 ★	80
MO-69T50	105	TR50 ☆	100





EXTENSION PIECES 3/8" SQUARE DRIVE

Reference	mm	mm	kg
MO-69523	140	21.5	0.12
MO-69533	264	21.5	0.27





IEC 60900 

SOCKET 6 WITH 1/4" FEMALE SIDES

Reference	 Female	
MO-69804	4	12
MO-69805	5	12
MO-698055	5.5	12
MO-69806	6	14
MO-69807	7	14
MO-69808	8	16
MO-69809	9	22
MO-69810	10	22
MO-69811	11	26
MO-69812	12	28
MO-69813	13	28
MO-69814	14	32





SOCKET 6 WITH 1/4" MALE SIDES

Reference	 Male	
MO-698M03	3	16
MO-698M04	4	18
MO-698M05	5	20
MO-698M06	6	22
MO-698M07	7	24
MO-698M08	8	25





EXTENSION 1/4"

Reference	 mm	
MO-69522	170	75



SHRINK FITTED EXTENSION 1/4"

Reference	 mm	 mm	
MO-69540	270	150	0.15





SOCKET WITH 12 1/2" FEMALE SIDES METRIC AND US SERIES

Reference			Reference		
MO-69408	8	60	MO-694-3/8	3/8	0.10
MO-69409	9	60	MO-694-7/16	7/16	0.15
MO-69410	10	60	MO-694-1/2SAE	1/2	0.15
MO-69411	11	65	MO-694-9/16	9/16	0.15
MO-69412	12	70	MO-694-5/8	5/8	0.15
MO-69413	13	70	MO-694-11/16	11/16	0.16
MO-69414	14	70	MO-694-3/4	3/4	0.20
MO-69415	15	75	MO-694-13/16	13/16	0.22
MO-69416	16	75	MO-694-7/8	7/8	0.26
MO-69417	17	80	MO-694-15/16	15/16	0.30
MO-69418	18	80	MO-694-1SAE	1	0.32
MO-69419	19	85	MO-694-1-1/16SAE	1-1/16	0.35
MO-69420	20	90	MO-694-1-1/8	1-1/8	0.38
MO-69421	21	100	MO-694-1-3/16SAE	1-3/16	0.42
MO-69422	22	100	MO-694-1-1/4	1-1/4	0.47
MO-69423	23	115			
MO-69424	24	125			
MO-69425	25	130			
MO-69426	26	135			
MO-69427	27	140			
MO-69428	28	145			
MO-69429	29	150			
MO-69430	30	155			
MO-69432	32	170			



6 SIDED MALE HEX KEY / SOCKET 1/2" SQUARE DRIVE

Reference	Male	
MO-694M04	4	0.10
MO-694M05	5	0.10
MO-694M06	6	0.10
MO-694M08	8	0.10
MO-694M10	10	0.10
MO-694M12	12	0.16
MO-694M14	14	0.16
MO-694M17	17	0.18
MO-694M19	19	0.22



EXTENSION PIECES 1/2" SQUARE DRIVE

Reference			
MO-69524	130	27	0.17
MO-69534	250	27	0.35



IEC 60900 

1/2" REDUCER FOR A 3/8" SOCKET



Reference	 mm	 g
MO-69539	79	60

3/8" REDUCER FOR A 1/4" SOCKET



Reference	 mm	 g
MO-69535	64	20



SOCKET 6 WITH 1/4" FEMALE SIDES TOWARDS MALE 3/8"

Reference	 mm	 g
MO-69537	54	30

EXPANDER 3/8" FEMALE TOWARDS MALE 1/2"

Reference	 mm	 g
MO-69536	75	40





MO-69308/23

SOCKETS 3/8" (9.53 mm) - 6 SIDED

Reference		
MO-69308/23	Tools composition on plastic case 410 x 120 x 75	1250

Composition

MO-69308	8	30
MO-69310	10	35
MO-69312	12	35
MO-69313	13	45
MO-69314	14	45
MO-69317	17	60
MO-69319	19	70
MO-69321	21	85
MO-69322	22	90
MO-69323	23	100
MO-69513	Reversible ratchet	600
MO-69523	Extension 130	124

SOCKETS 1/2" (12.7 mm) - 12 SIDED

Reference		
MO-69408/23	Tools composition on plastic case 410 x 120 x 75	1500

Composition



MO-69408	8	60
MO-69410	10	60
MO-69412	12	70
MO-69413	13	70
MO-69414	14	70
MO-69417	17	80
MO-69419	19	85
MO-69421	21	100
MO-69422	22	100
MO-69423	23	115
MO-69514	Reversible ratchet	600
MO-69524	Extension 125	250

Other references 1/2", consult us.

IEC 60900 

RACHET SPANNERS

With mechanical locking.

Reference		 mm	 kg
MO-69512	1/4"	125	0.15
MO-69513*	3/8"	200	0.45
MO-69514*	1/2"	250	0.75

* With mechanical locking.



MO-69512





TORQUE WRENCH 3/8" SQUARE DRIVE

MO-69050 non-reversible with right hand thread.

MO-69051 with reversible pawl and right or left hand thread.

MO-69054 with reversible spindle function.

Reference	 mm	\vec{F}_{Nm}	 kg
MO-69050	340	8 to 60	0.9
MO-69051	230	4 to 20	0.9
MO-69054	340	8 to 60	0.9

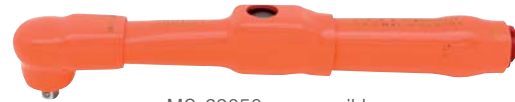

MO-69050 no reversible





MO-69051 reversible



MO-69054 reversible

FULLY INSULATED SCISSORS

Completely insulated pair of scissors, ambidextrous.

Reference	 mm	 g
MO-72100E	132	80



 On flats

 Diameter

 Dimensions

\vec{F}_{Nm} Clamping torque

 Weight



SCREWDRIVERS KIT

IEC 60900

Reference	Composition
KIT-03	POZIDRIV screwdriver N°1 MO-65242 POZIDRIV screwdriver N°2 MO-65244 Flat blade screwdriver 3.5 x 100 mm MO-65204 Flat blade screwdriver 5.5 x 125 mm MO-65206 Flat blade screwdriver 8 x 175 mm MO-65209



PLIERS KIT

Reference	Composition
KIT-07	Universal plier overall length 180 mm MO-66002 Water pump plier overall length 250 mm MO-66502 End stripping plier 160 mm MO-67302 Bent snipe nose plier overall 160 mm MO-66402 Cable cutter 170 mm MO-67500



INTERVENTION KIT

Reference	Composition
KIT-04	POZIDRIV screwdriver N°1 MO-65242 POZIDRIV screwdriver N°2 MO-65244 Flat blade screwdriver 3.5 x 100 mm MO-65204 Flat blade screwdriver 5.5 x 125 mm MO-65206 Flat blade screwdriver 8 x 175 mm MO-65209 End stripping plier overall 160 mm MO-67302 Bent snipe nose plier overall 160 mm MO-66402 Cable cutter 170 mm MO-67500



COMPLETE INTERVENTION KIT

Reference	Composition
KIT-05	POZIDRIV screwdriver N°1 MO-65242 POZIDRIV screwdriver N°2 MO-65244 Flat blade screwdriver 3.5 x 100 mm MO-65204 Flat blade screwdriver 5.5 x 125 mm MO-65206 Flat blade screwdriver 8 x 175 mm MO-65209 Universal plier overall 180 mm MO-66002 Water pump plier overall 250 mm MO-66502 End stripping plier overall 160 mm MO-67302 Bent snipe nose plier overall 160 mm MO-66402 Cable cutter 170 mm MO-67500



COMPOSITION OF INSULATED TOOLS 3/8" METRIC DIMENSIONS

Reference	Composition
MO-69308/30	Ratchet wrench 3/8" with mechanical locking MO-69513. Extension 3/8" length 130 mm MO-69523
	4 male sockets with sides 3/8" 4, 5, 6, 8 mm (MO-69394, MO-69395, MO-69396, MO-69398)
	12 female sockets 6 sides 3/8" 8, 10, 12, 13, 14, 16, 17, 18, 19, 21, 22, 23 mm (MO-69308, MO-69310, MO-69312, MO-69313, MO-69314, MO-69316, MO-69317, MO-69318, MO-69319, MO-69321, MO-69322, MO-69323)
	6 female sockets 6 sides 3/8" lanyard 16, 17, 18, 19, 21, 22 mm (MO-69616, MO-69617, MO-69618, MO-69619, MO-69621, MO-69622) Plastic box + foam 440 x 320 x 100 mm



IEC 60900 



COMPOSITION OF INSULATED TOOLS 3/8" US DIMENSIONS

Reference	Composition
MO-69308/30US	Ratchet wrench 3/8" with mechanical locking MO-69513. Extension 3/8" length 130 mm MO-69523 T wrench 3/8" length 200 mm MO-69543
	7 male sockets 6 sides 3/8" SAE 1/8", 5/32", 3/16", 7/32", 1/4", 5/16", 3/8" (MO-6939M18, MO-6939M532, MO-6939M316, MO-6939M732, MO-6939M14, MO-6939M516, MO-6939M38)
	13 female sockets 6 sides 3/8" SAE 1/4", 5/16", 3/8", 7/16", 1/2", 9/16", 5/8", 11/16", 3/4", 13/16", 7/8", 15/16", 1" (MO-69714SAE, MO-697516, MO-69735, MO-69736, MO-69737, MO-69738, MO-69739, MO-69740, MO-69741, MO-69742, MO-69778, MO-6971516, MO-6971SAE) Plastic box + foam 440 x 320 x 100 mm



COMPOSITION OF INSULATED TOOLS 3/8" METRIC DIMENSIONS

Reference	Composition
MO-69308/31	Ratchet wrench 3/8" with mechanical locking MO-69513 Extension 3/8" length 140 mm MO-69523 Male socket 6 sides 3/8" MO-69395
	Female sockets 6 sides 3/8" 8, 10, 12, 13, 14, 16, 17, 19, 21, 22, 23 (MO-69308, MO-69310, MO-69312, MO-69313, MO-69314, MO-69316, MO-69317, MO-69319, MO-69321, MO-69322, MO-69323) Plastic box + foam 440 x 320 x 100 mm





COMPOSITION OF INSULATED TOOLS 3/8" METRIC DIMENSIONS

Reference	Composition
MO-69308/32	Ratchet wrench 3/8" with mechanical locking MO-69513 Extension 3/8" length 140 mm MO-69523 Male socket 6 sides 3/8" 5 mm (MO-69395)
	12 Female sockets 6 sides 3/8" 8, 10, 12, 13, 14, 16, 7, 18, 19, 21, 22, 24 MO-69608, MO-69610, MO-69612, MO-69613, MO-69614, MO-69616, MO-69617, MO-69618, MO-69619, MO-69621, MO-69622, MO-69624 - Plastic box + foam 440 x 320 x 100 mm



COMPOSITION OF INSULATED TOOLS 3/8" METRIC DIMENSIONS

Reference	Composition
MO-69308/33	Ratchet wrench 3/8" with mechanical locking MO-69513 Extension 3/8" length 250 mm MO-69533 T wrench 3/8" length 200 mm MO-69543 5 male sockets 6 sides 3/8" 4, 5, 6, 7, 8 mm (MO-69394, MO-69395, MO-69396, MO-69397, MO-69398)
	18 Female sockets 6 sides 3/8" 6, 7, 8, 9, 10, 11, 12, 13, 14, 15, 16, 17, 18, 19, 21, 22, 23, 24 mm MO-69306, MO-69307, MO-69308, MO-69309, MO-69310, MO-69311, MO-69312, MO-69313, MO-69314, MO-69315, MO-69316, MO-69317, MO-69318, MO-69319, MO-69321, MO-69322, MO-69323, MO-69324 + expander 3/8" - 1/2" MO-69536 Plastic box + foam 440 x 320 x 100 mm



COMPOSITION OF INSULATED TOOLS 1/2" METRIC DIMENSIONS

Reference	Composition
MO-69408/30	Ratchet wrench 1/2" MO-69513 Extension 1/2" length 130 mm MO-69524 T wrench 1/2" length 300 mm MO-69544 5 male sockets 6 sides 1/2" 8, 10, 12, 14, 17 mm (MO-694M08, MO-694M10, MO-694M12, MO-694M14, MO-694M17)
	24 female sockets 12 sides 1/2" 8, 9, 10, 11, 12, 13, 14, 15, 16, 17, 18, 19, 20, 21, 22, 23, 24, 25, 26, 27, 28, 29, 30, 32 mm (MO-69408, MO-69409, MO-69410, MO-69411, MO-69412, MO-69413, MO-69414, MO-69415, MO-69416, MO-69417, MO-69418, MO-69419, MO-69420, MO-69421, MO-69422, MO-69423, MO-69424, MO-69425, MO-69426, MO-69427, MO-69428, MO-69429, MO-69430, MO-69432) Plastic box + foam 440 x 320 x 100 mm



COMPOSITION OF INSULATED TOOLS 1/2" US DIMENSIONS

Reference	Composition
MO-69408/30US	<p>Ratchet wrench 1/2" MO-69513 Extension 1/2" length 130 mm MO-69524 T wrench 1/2" length 300 mm MO-69544</p> <p>7 male sockets 6 sides 1/2" 5/16", 3/8", 7/16", 1/2", /16", 5/8", 3/4" (MO-694M516, MO-694M38, MO-694M716, MO-694M12SAE, MO-694M916, MO-694M58, MO-694M34)</p> <p>15 female sockets 12 sides 1/2" SAE , 7/16", 1/2", 9/16", 5/8", 11/16", 3/4", 13/16", 7/8", 15/16", 1", 1-1/16", 1-1/8", 1-3/16", 1-1/4" (MO-69438, MO-694716, MO-69412SAE, MO-694916, MO-69458, MO-6941116, MO-69434, MO-6941316, MO-69478, MO-6941516, MO-6941, MO-69421116SAE, MO-694118, MO-6941316, MO-694114)</p> <p>Plastic box + foam 440 x 320 x 100 mm</p>



IEC 60900



COMPOSITION OF INSULATED TOOLS 1/2" METRIC DIMENSIONS

Reference	Composition
MO-69408/31	<p>Ratchet wrench 1/2" MO-69513 Extension 1/2" length 130 mm MO-69524</p> <p>10 female sockets 12 sides 1/2" 8, 10, 12, 13, 14, 17, 19, 21, 22, 23 mm (MO-69408, MO-69410, MO-69412, MO-69413, MO-69414, MO-69417, MO-69419, MO-69421, MO-69422, MO-69423)</p> <p>Plastic box + foam 440 x 320 x 100 mm</p>



COMPOSITION OF INSULATED TOOLS 1/4" METRIC DIMENSIONS

Reference	Composition
MO-69804/23	<p>Ratchet wrench 1/4" MO-69512 Extension 1/4" length 150 mm MO-69522</p> <p>Shrink fitted extension 1/4" length 270 mm MO-69540</p> <p>6 male sockets 6 sides 1/4" 4, 5, 6, 7, 8 mm (MO-698M03, MO-698M04, MO-698M05, MO-698M06, MO-698M07, MO-698M08)</p> <p>11 female sockets 6 sides 1/4" 4, 5, 6, 7, 8, 9, 10, 11, 12, 13, 14 (MO-69804, MO-69805, MO-69806, MO-69807, MO-69808, MO-69809, MO-69810, MO-69811, MO-69812, MO-69813, MO-69814)</p> <p>Plastic box + foam 440 x 320 x 100 mm</p>





COMPOSITION OF INSULATED TOOLS 1/4" US DIMENSIONS

IEC 60900

Reference	Composition
MO-69804/23US	<p>Ratchet wrench 1/4" MO-69512</p> <p>Extension 1/4" length 150 mm MO-69522</p> <p>Shrink fitted extension 1/4" length 270 mm MO-69540</p> <p>6 male sockets 6 sides 1/4" SAE 1/8", 9/64", 5/32", 3/16", 7/32", 1/4" (MO-698M18, MO-698M964, MO-698M532, MO-698M316, MO-698M732, MO-698M14)</p> <p>10 female sockets 6 sides 1/4" 3/16", 7/32", 1/4", 3/32", 5/16", 11/32", 3/8", 7/16", 1/2", 9/16" (MO-698316, MO-698732, MO-69814SAE, MO-698932, MO-698516, MO-6981132, MO-69838, MO-698716, MO-69812SAE, MO-698916)</p> <p>Plastic box + foam 440 x 320 x 100 mm</p>



COMPOSITION OF INSULATED TOOLS 3/8" METRIC DIMENSIONS

Reference	Composition
MO-69608DYN	<p>Torque wrench with uni-directional ratchet 3/8" MO-69050</p> <p>Extension 3/8" length 140 mm MO-69523</p> <p>T wrench 3/8" length 130 mm MO-69542</p> <p>Male socket 3/8 and six sides of 6 mm MO-69396</p> <p>10 female sockets 3/8 and six female sides of 8, 10, 12, 13, 14, 16, 17, 18, 19, 21 mm (MO-69608, MO-69610, MO-69612, MO-69613, MO-69614, MO-69616, MO-69617, MO-69618, MO-69619, MO-69621)</p> <p>Plastic box + foam 440 x 320 x 100 mm</p>



BTR 4 SCREW TIGHTENING KIT

Tightening tool kit for screw with BTR head BTR (CHC) six sides of 4. Suitable particularly for identically tightening connection circuit breakers, meters and various kits used by the ERDF for the equipment of the control panels.

Reference	Composition
KIT-MO68404DYN	<p>1 torque screwdriver with limited torque set delivered with short blades (30 mm) and long blades (95 mm) MO-68404-DYN</p> <p>1 short blade screwdriver with "ball" handle MO-68404C</p> <p>1 male offset right angle wrench with hexagonal end with 4 flat sections MO-69904C</p> <p>1 screwdriver with hexagonal end with 4 flat sections MO-68404</p>

Delivered in a bag.



ELECTRICIAN TOOL BAG

Foamed structure and reinforced base.

Adjustable shoulder strap. Delivered without tools.

- M-87370 : 8 outside pockets.

Interior: mesh pocket and removable tool holder.

- MO-37 : 4 outside pockets and large compartment inside. Transport handles.

Reference	mm	kg
M-87370	440 x 330 x 160	1.1
MO-37	400 x 310 x 250	0.6

THE +

1 Moving to the rear side for mounting on trolley.



M-87370



MO-37

BACKPACK FOR TOOLS

Semi-rigid and foamed structure. Reinforced handle.

4 exterior pockets. Velcro and straps for storage for insulating mat.

Interior: pocket for a laptop, pockets, detachable reversible tray and elastic straps for tools.

Support pads and reinforced bottom. Delivered without tools.

Reference	mm	kg
MO-38	400 x 330 x 180	0.6

THE +

1 For transporting tools, laptops and insulating mats.



TOOL BOX

Flexible and detachable protective flap for direct access to tools. Metal up-and-over handle, with foam padding.

8 exterior pockets, including one adjustable pocket for a saw and 10 vertical internal pockets. Adjustable shoulder strap. Support pads and reinforced bottom. Delivered without tools.

Reference	mm	kg
MO-39	480 x 320 x 230	0.9

THE +

1 Bulky size for direct access to tools.





BACKPACK WITH WHEELS FOR TECHNICIANS

2 methods of use: backpack or trolley mode.
 Flexible shock-absorbent structure. Front and side pockets for documents and PPE (helmet, gloves, mat and rod).
 Ergonomic straps and foam padded back.
 Silent rubber wheels, replaceable.
 Extremely comfortable to use.
 Reflective stripes.

MO-102 : For measuring equipment.

Pockets for laptop, documents and 3 rigid trays with adjustable height. Detachable rolling base (MO-101) and quick assembly on the bag. Black.

MO-102-0 : For electric tools

Vertical tray for arranging tools in several slots. Central pocket for large tools. Fixed rolling base. Blue.

Accessory (MO-103) : pocket with transparent cover for quickly viewing the contents. Sold empty.



MO-102



Reference	Characteristics	mm	kg	Capacity
MO-102	Bag for measuring tools	500 x 350 x 230	4.6	40 L
MO-102-0	Bag for tools	550 x 410 x 250	4.1	35 L
MO-101	Only rolling base	410 x 230	1.4	-
MO-103	Pocket	330 x 170	0.6	-



Ergonomic straps



Storage for protective helmet



Storage for laptop

THE +

- 1 Stability and direct access to contents.
- 2 Arranging the tools and PPE.
- 3 Adjustable arrangement (MO-102).
- 3 Ergonomic straps.
- 4 Storage for protective helmet.
- 5 Storage for laptop.
- 6 Pocket.



Pocket MO-103



MO-102-0



FLAT TOOL CASE

Made of high-resistance textile. Carry handle. Elastic straps for holding tools on the two interior surfaces. Reversible and removable tool-holder tray. Sold without tools.

Reference	mm	kg
M-87303	400 x 350 x 40	0.5



TOOL BAG

Made of split grain leather, black. Carry handle. 1 hold-all pocket, 1 separation forming a tool-holder tray and 1 tool-holder flap. Closed using 2 straps with loops. Riveted assembly and reinforced bottom. Delivered without tools.

Reference	mm	kg
MO-34	410 x 280 x 150	3.2



THE +

1 For organized and optimized storage.

TOOL BAG

Made of full grain leather, natural colour. Transport handle and adjustable shoulder strap. 2 interior pockets separated by a tool-holder tray. Closed using 3 straps with loops. Reinforced bottom. Sewn bag assembly. Delivered without tools.

Reference	mm	kg
MO-36	200 x 250 x 450	4.8



ROLL BAG FOR PPE

Large capacity for storing PPE (gloves, helmet, carpet, boots and other accessories). Adjustable carry straps. Double-zip closing. Exterior transparent pocket.

Reference	mm	kg
MO-50	Ø 250 x L 620	0.5

THE +

1 Allows storing all PPE and a 60 cm wide insulating mat





LOW VOLTAGE COMPLETE SET. COMPLETE EQUIPMENT FOR LIVE LINE (LV) INTERVENTIONS.



face shield with MO-510-03 or electrician helmet with MO-510-03/2

Reference
MO-510-03 *
MO-510-03/2 *

Composition

PERSONAL EQUIPMENT	
MO-286	1 face shield with MO-510-03
MO-185-BL	1 electrician helmet with MO-510-03/2
CG-98-C	1 working gloves size C
CG-05-C	1 rubber gloves size B
CG-36-1	1 carrying bag for rubber gloves
MP-42/16	1 insulating mat 3 mm
VOLTAGE DETECTOR	
MS-917	1 voltage detector
INSULATING	
MP-26-A	10 insulating caps
MP-35/12	1 insulating blanket
MP-4110	10 wood clamps for insulating blanket
MP-32/15	6 line protectors 1.50 m
MP-19LOT	insulating adhesive tapes
INSULATING TOOLS	
MO-61001	1 stripping knife
MO-67502	1 cable cutter 230 mm
MO-68008/19	1 open end spanners set with 8/10/11/12/13/14/17/19 mm

following

INSULATED TOOLS IEC 60900 	
MO-69903	1 right angle hexagonal key wrench 3 mm
MO-69904	1 right angle hexagonal key wrench 4 mm
MO-69906	1 right angle hexagonal key wrench 6 mm
MO-751	1 insulating folding rule
MO-69003	1 adjustable spanner 250 mm
MO-66002	1 universal pliers 180 mm
MO-66202	1 round nose pliers 160 mm
MO-66502	1 water pump pliers 250 mm
MO-67102	1 side cutter 160 mm
MO-69308/23	1 sockets 3/8" wrench set with 10 sockets: 8, 10, 12, 13, 14, 17, 19, 21, 22, 23
MO-65205	1 flat blade screwdriver 4 x 100
MO-65207	1 flat blade screwdriver 6.5 x 150
MO-65209	1 flat blade screwdriver 8 x 175
MO-65232	1 Phillips screwdriver n° 1
MO-65234	1 Phillips screwdriver n° 2
MO-65236	1 Phillips screwdriver n° 3

* Delivered without tool bag.

Tool bag to order separately

Reference	Characteristics
MO-34	Leather tool bag , see page 141
MP-01	Bag for insulating mats, see page 33

Reference	Characteristics
M-87384	Bag for face shield and helmet, see page 37
M-87386	Multi-pocket electrician bag, see page 33

INTERVENTION KIT FOR ELECTRICIANS

IEC 60900 



Reference
MO-38510

Composition

TRANSPORT	
M-87370	1 tool bag
PERSONAL EQUIPMENT	
CG-05-C	1 pair of insulating gloves size C
MO-11001	1 safety glasses
LOCKING	
AL-230-111	1 safety padlock
INSULATED TOOLS	
MO-65204	Flat blade screwdriver - 3.5 x 100 mm
MO-65206	Flat blade screwdriver - 5.5 x 125 mm
MO-65209	Flat blade screwdriver - 8 x 175 mm
MO-65242	POZIDRIV screwdriver - N°1 4.5 x 80 mm
MO-65244	POZIDRIV screwdriver - N°2 6 x 100 mm
MO-66002	Universal plier - length 180 mm
MO-66402	Bent snipe nose plier - length 160 mm
MO-67302	End stripping plier - length 160 mm
MO-67500	Cable cutter - length 180 mm
MO-66502	Water pump plier - length 250 mm

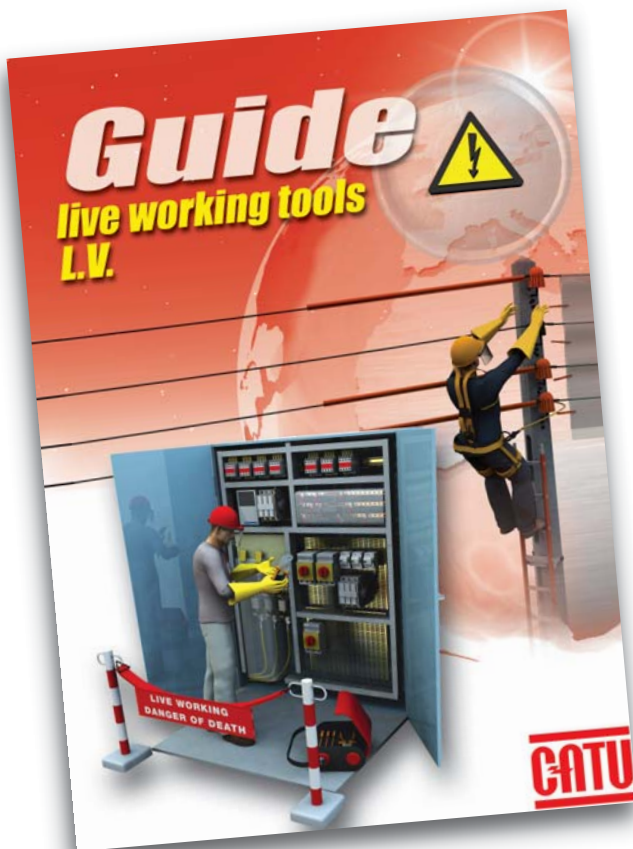

Our LV Live line working guide is available.

All our guides and catalogues are available on request or downloadable from our website.

www.catuelec.com





MINI JUMPER CLAMPS FULLY INSULATED FOR SWITCHBOARD USE

These clamps are specially designed for use on energized parts in LV installations (switchboards, etc.) to make temporary connections. Isolated bronze jaws designed to axially grip conductors can be used on threaded bolts or shanks and nuts. All other models in this series tighten with T-handle screw, and receive cable terminals

Reference	mm	kg
MC-141	150 x 75 x 25	0.20
MC-142	33 x 38 x 58	0.13
MC-143	115 x 70 x 25	0.15
MC-144	23 x 75 x 150	0.28
MC-145	23 x 70 x 110	0.22
MC-146	23 x 70 x 110	0.23
MC-147	100 x 70 x 25	0.10
MC-147/1	100 x 70 x 25	0.10
MC-148	80 x 70 x 25	0.15
MC-148/1	80 x 65 x 25	0.10
MC-149	160 x 60 x 55	0.30

MC-141



Six-sided
17-19 mm.

MC-142



Adjustable clamp
round Ø 6-10 mm
flat 5 mm.

MC-143



Flat bar,
thickness
2-25 mm.

MC-144



Round 8-12
square 9-10 mm.

MC-145

Wire clamp for
stripped cables
Ø 3 to 10 mm.



MC-146

Wire clamp for
stripped
cables
Ø 10 to 24 mm.



MC-149

Flat bar,
thickness
20-30.



MC-147

Threaded rod M8
MC-147.
Threaded rod M10
MC-147/1.



MC-148

For shunt 200 A.



Clamp with tapped revolving rod end M8, 200 A shunt. To be used with an insulating six-sided male hex key 5 mm.

MC-148/1

For 10
to 50 mm² cable.

Clamp with tapped revolving rod end M8.



JUMPER CABLES

LV live working tools. Delivered with socket screwing ISO M8. Insulated copper cable H 07 RN-F. Nominal intensity 200 A. Insulated cover.

Reference	↔	Section mm ²	Intensity A	kg
MC-153/05	0.5 m	35	200	0.27
MC-153/10	1 m	35	200	0.57
MC-153/30	3 m	35	200	1.72
MC-153/60	6 m	35	200	3.46
MC-155/05	0.5 m	50	250	3.80
MC-155/10	1 m	50	250	7.60
MC-155/20	2 m	50	250	1.52
MC-155/30	3 m	50	250	2.28
MC-155/60	6 m	50	250	4.56
MC-155/80	8 m	50	250	6.08



JUMPER CABLE WITH INSULATED JUMPER CLAMPS

Reference	↔ mm	g
MC-121	60 x 25	50
MC-122	125 x 35	100
MC-123	125 x 35	100
MC-124	125 x 35	100

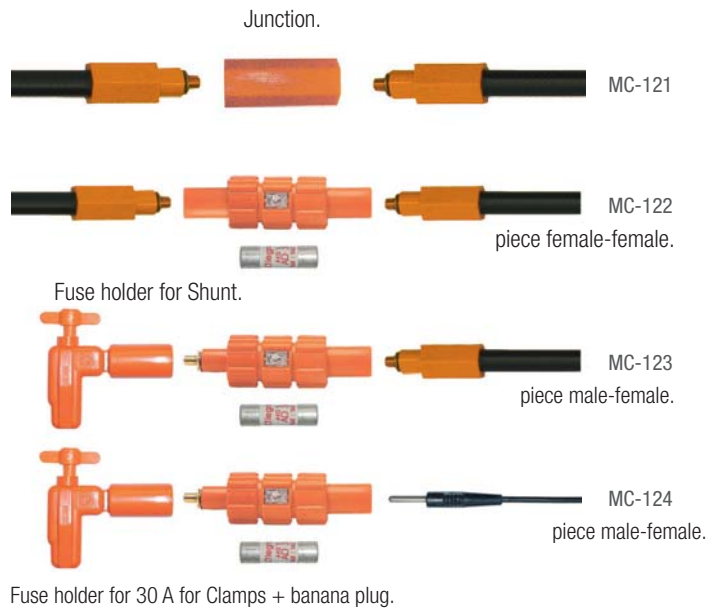

JUMPER CABLE WITH INSULATED JUMPER CLAMPS

Cable H 07 RN-F of 25 mm². Continuous rating: 75 A. 2 clamps MC-120. 150 x 100 x 60 mm and 190 g each. Tightening capacity. 12 mm (- flat). Spring tightening. Connector for cable 8 mm. Rated insulation: 1 500 V. Icc = 5 kA/1 s.



Reference	↔ mm	kg
MC-120/15	1.5 m	0.85
MC-120/50	5 m	1.95
MC-120/100	10 m	4





THREADED ADAPTER

Cylindrical body diameter 10 mm to fits on panel network thread of switchboard etc... Total length 50 mm.

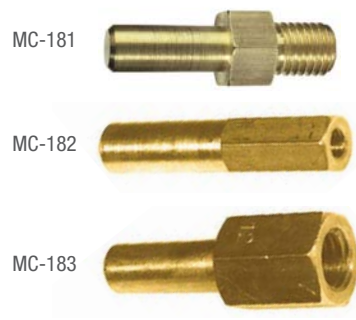

Reference	 mm	 mm	
MC-181	50 x 13	M10	50
MC-182	50 x 10	M8	27
MC-183	50 x 17	M12	48



SHUNT TELESCOPIC PROBE

Connector with insulated probe. Retractable cover.

Reference	Sections mm ²	Intensity A
MC-126	1.5 to 16	60
MC-126/1	10 to 70	100

Reference	 mm	
MC-150	173 x Ø 32	185



Connector with insulated probe.

Retractable cover.

BYPASS HOUSING

The six removable fittings can be separated by the triangular spanner. The housing allows on each side to connect 3 by pass jumpers.

Reference	Composition
MC-156	Box 40 x 80 x 158 mm
MC-156/1	Spare part
MO-237-D	Triangular spanner witch T hande

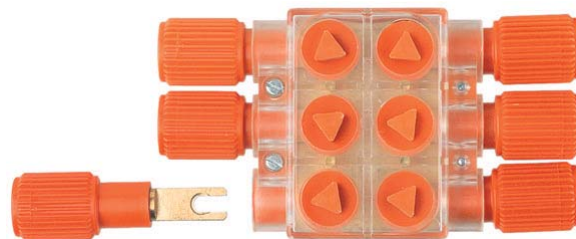

JUMPER CONNECTING BOX WITH FUSE

Shunt for collective pipes.

Reference	Intensity A
MC-116	from 30 to 200

The shunt for collective channeling is a box used to make sure, before proceeding to the replacement of a molten fuse situated on a channeling, that the defect which brought about the molten is eliminated. This box is used with a fuse when the (nominal) assigned intensity of the channeling is < 100 A and with 2 fuses when this intensity is included between 100 A and 200 A. It can also be used to open a circuit in load, for example to change a damaged accessory such as a pin.



CABLE IDENTIFIER

The MX-400 includes a modulator A and a receiver B.

The MX-400 is a cable identifier that is particularly well suited for quickly identifying underground cables and insulating overhead lines. It is also designed for identifying phases. This identifier is used on any type of power distribution network with rated voltages of 230 to 400 Volts.

Operating voltage: 230/400 V +/- 10%.



Frequency: 50 Hz +/- 10%.

Operating temperature: - 10° to + 55°C.

Storage temperature: - 20° to + 70 .

Class II modulator. 

The **modulator** is an electronic power system that draws current pulses in 10-millisecond intervals at a frequency of 1 Hertz. Current limited by fuse, HPC 100 kA aM 10 A.

Reference	 mm	 kg
MX-400	510 x 465 x 216	10.6

Comes complete with an ABS case, 2 cables, and 1 amperemetric clamp.



H07RNF power cables. (6 mm² and 3 m length). The connection is made between phases for identifying the cable or between phase and neutral for identifying a phase. After connection, the device is immediately live, as indicated by two 230 and 400 Volts lights.

The receiver is equipped with two sensors that detect the passage of pulses drawn by the modulator. Once these pulses are received, the device emits a light signal, confirmed with a beep after three seconds. Receiver powered by 9 V lithium type 6LR61 battery. Sensor sensitivity adjustable to 15 levels. Detection can easily be adjusted, which accordingly affects identification accuracy.



The phase is identified with an amperemetric clamp connected to the receiver and positioned around the phase to be identified. When the clamp detects pulses drawn by the modulator, the receiver emits a light signal, confirmed by a beep after three seconds.

Accessories

Reference	Characteristics
MX-400/1	Modulator + receiver
MX-400/6	Receiver
MX-400/7	Amperemetric clamp
MC-1421	Connection clamp



Ask for your own **LV** Voltage Detector

Detex™

The family grows again!

Generation of voltage check (VAT) operations and voltage detectors see page 96.

EN 61243-3 (2010) / 
IEC 61243-3 (2009)
EN 50110-1
CE

MS-917-VE



917-L



920-EX



MV Substation equipment



Safety equipment	150
Substation equipment	151
Voltage detectors and short-circuiting systems for substations with bare conductors	152
Voltage detectors	153
Phase comparators	155
Two-pole phase comparator and permanent indicator	156
IEC short-circuiting and earthing systems for MV substations	157
Clamps for M.V. installations and substations	159
Short-circuiting and earthing systems	160
VPIS and VDS systems for M.V. cubicles	163
Additional safety equipment	165
Life saving kits	167





Keep your substations in compliance

SPECIAL REGULATORY SIGNALING

The standard recommends the following signaling in substations :

- A substation poster,
- Two posters about what to do in the event of an indoor or outdoor electrical emergency,
- A poster displays the service rules.

All of these posters come in kits that were specially designed by CATU to get your substations in compliance.

NF C 13-100



SAFETY EQUIPMENT

The standard recommends the following service equipment :

- An insulating platform or an insulated mat,
- A rescue stick,
- A pair of insulating gloves adjusted to the substation's rated voltage,
- A voltage detector (see below for information)
- A grounding and short circuit device (see below for information)
- A glove box,
- A fuse holder.

CATU has assembled all of the service equipment into kits to simplify your selection and to bring your facilities into compliance right away. This equipment must include a suitable voltage detector.



INTERVENTION KITS

Reference	Characteristics
KIT-01	Intervention kit with insulating platform 24 kv
KIT-02	Intervention kit with insulating platform 36 kv
KIT-10	Intervention kit with insulating mat delivered with a protective P.V.C. container

KIT-01	KIT-02	KIT-10	Composition of kits	Characteristics	mm	
•	–	•	CG-3-10-NR	Insulating rubber gloves Class 3	26 500 V max	Size (10)
–	•	–	CG-4-10-NR	Insulating rubber gloves Class 4	36 000 V max	Size (10)
•	•	•	CG-35/2 *	Rubber gloves box	–	101 x 224 x 476
•	•	•	CI-23 *	Fuse holder	Ø maxi 85 mm	90 x 240 x 260
•	•	•	CS-45 **	Rescue stick	45 000 V max	Long. 1.65 m
•	•	•	CI-06-D	Wall mounted supports	Delivered with CS-45	–
•	–	–	CT-7-25/1	Insulating platform	24 000 V max	500 x 500 x 220
–	•	–	CT-7-40/1	Insulating platform	40 000 V max	500 x 500 x 220
–	–	•	MP-42/16	1 insulating MAT IEC-61111 Thickness 3 mm	Class 3 - 26.5 kV	0.6 x 1 m
–	–	•	MP-20	Mat storage box	–	Ø 100 x 700 mm

* Delivered with fixations. **Delivered with wall mounted supports CI-06-D.



CG-35/2



CI-23



CI-06-D



CG-3-10-NR
CG-4-10-NR



MP-20



CT-7-25/1
CT-7-40/1

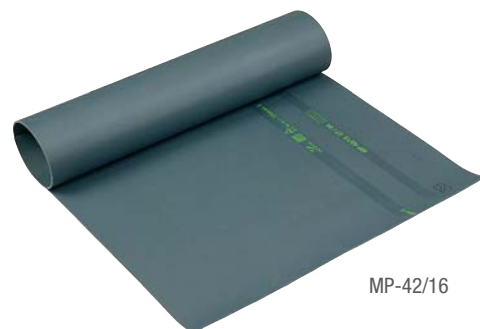

MP-42/16



CS-45



Dimensions



IEC ELECTRONIC VOLTAGE DETECTORS, "COMPACT SERIE" FOR INDOOR AND OUTDOOR USE

Ultimate technology of voltage detector "Head Capacitive Technology".
Compact and light, it offers a wide band (10/36 kV).

Operating check :

By pressing the TEST button:

- A **RED** LED flashes on.
- Powerful rated audible signal > 60 dB(A)/2 m.
- When loosening the button, the timed **GREEN** LED lights up.

While remaining on, it indicates the good working order of the detector.

Characteristics :

- Precise and stable operating threshold.
- High environmental resistance (impacts, vibrations, moisture).
- Temperature conditions: class N (IEC -61243-1 standard).
- Use from 50 to 60 Hz.



IEC VOLTAGE DETECTOR

In compliance with IEC-61243-1.

CC-765 high environmental resistance : impacts, vibrations, moisture.

Recommended stick CE-4-21-C or K.

Refer to technical specifications on page 201.

IEC 61243-1



Reference	Characteristic	~	mm	g
CC-765-55/20*	In storage box	5.5 - 20	Ø 59 x 270	350
CC-765-3/10*	In storage box	3 - 10	Ø 59 x 270	350
CC-765-10/36*	In storage box	10 - 36	Ø 59 x 270	350
CC-765-10/30*	In storage box	10 - 30	Ø 59 x 270	350

(*) Specify type of mounting when ordering : C or K.
Devices delivered with instructions in plastic box and batteries, mixed contact electrode
Centring bracket/flag for use with Nevers equipment (refer to page 178) and instruction manual.
Dimensions Ø 59 x 270 mm.
FOR OTHER VOLTAGE RANGE : CONTACT US.



CC-765-10/30 - C

IEC INSULATING STICK FOR VOLTAGE DETECTOR

Parts made of composite epoxy resin and glass fibre tubes and polyurethane foam. Locked with a push button. Rod for aerial networks and electrical installations.

For VAT and Grounding.

Reference	~	↔	kg
CE-4-21-(*)	90 kV	2 m	1.5

(*) Add end-fitting: C-E-K.

IEC 62193 (2003)

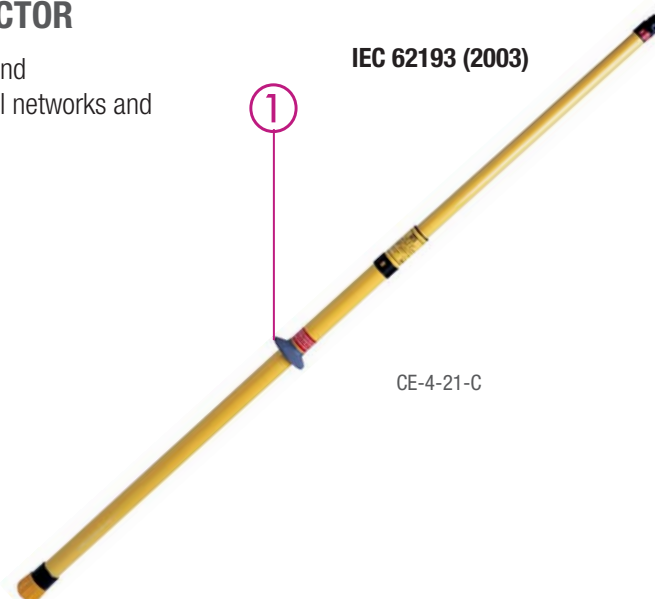

CE-4-21-C

THE

1 Hand guard.

IEC ELECTRONIC VOLTAGE DETECTOR, WITH ANTENNA FOR INDOOR AND OUTDOOR USES

Ultimate "head capacitive technology" of voltage detector.

- Universal application 50 / 60 Hz and wide band of voltage from 5 to 30 kV.
- Type S (Substation) with electrode extension.
- The electrode extension is designed to ensure no inside failure.
- Equipped with its insulating stick : Assembly by screwing.

Voltage presence is indicated by:

RED flashing LED (very bright, visible at more than 20 m in direct lighting).
Powerful rated audible signal > 67 dB (A) / 1.5 m.

Characteristics:

- Temperature conditions: class N (-25 to 55°C).
- Type S (with electrode extension).
- Electrode extension diameter : 14 mm.
- Power supply: 1 standard 9 V battery 6LR61.
- Network frequencies : 50 and 60 Hz.
- Contact electrodes fitted by screwing and easily interchangeable.
- Packaging: supplied in a carrying bag with zip (930 mm x 200 mm) and transparent side pocket.
- In compliance with the standard IEC 61243-1 Ed 2 (2003).
- CE marking complies with EMC immunity regulations.

Reference	~	↔	g
CC-965-10/30	10 to 30	Length: 1.55 m Diameter: 59 mm	850
CC-965-5/15	5 to 15	Length: 1.45 m Diameter: 59 mm	820



IEC 61243-1
CE



Accessory

Plastic carrying case: REF. M78723.



Canvas bag



THE +

- 1 360 ° light indication.
- 2 Delivered in a waterproof canvas bag.
- 3 With insulating stick



↔ Total length 📦 Weight 📏 Dimensions



VOLTAGE DETECTOR FOR M.V. SUBSTATION (INDOOR USE)

It's equipped with its built-in device for the checking operation.

The indication "voltage present" is visualized on 360° by a high brightness red LED.

High environmental resistance: Shocks, drop, vibration.

Rugged molded thermoplastic housing.

Powered with a lithium battery.

The battery life is more than 8 years.

External Ø 58.5 mm compatible with the passoped glasses. Telescopic stick version for reduced space requirement.

EN 61243-1
CE

Reference				
		Folded up		
CL-465-10/30-M *	10 - 30 kV	-	1.35 m	1
CL-465-10/30-2 **	10 - 30 kV	0.75 m	1.18 m	0.9

* Delivered in vinyl sheath with wall brackets CI-06-D.

** Delivered in canvas, waterproofed with ramp.

THE

- 1 The battery life is more than 8 years.
- 2 The indication "voltage presence" is visualized on 360°.



CL-465-10/30-M



CL-465-10/30-2

TWO-POLE PHASE COMPARATORS FOR INDOOR USE

The **DETEX CL-8-36** detects differences in voltage between any two points of an installation indicated by LED's. It also enables assessment of the order of magnitude of the residual voltage induced by nearby live lines or circuits, and thus differentiates it from the one provided directly from a high voltage source.

Two 1.25 m elements with removable probes, connected via a high-insulation lead. High dielectric quality insulating material.

Reference	Voltage (AC)	aerial		kg
		assembled	dismantled	
CL-8-36	2 to 36 kV	1.25 m	0.62 m	1.1
CL-8-36/1 *	2 to 36 kV	1.25 m	0.62 m	1.3

* As CL-8-36 tester with 2 probes extenders 0.550 m.
Cable 1.5 m for CL-8-36 and 3 m for CL-8-36/1. Delivered in plastic case.

Accessories :

Reference	Description
C-92-20	Spare probe 0.550 m
CL-8-05	Probe extenders 0.550 m



CL-8-36

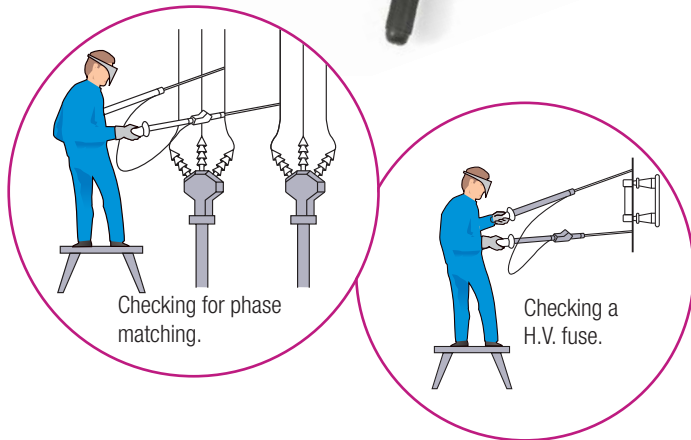

Checking for phase matching.

Checking a H.V. fuse.

OPERATING TESTERS

To perform mandatory testing on the controllers before and after each use.

Reference	Characteristic	Voltage	Dimensions mm	kg
CL-1-06	Delivered in case with lead	Adjustable 10, 20, 30 kV	190 x 32 x 65	0.32



CL-1-06

INFO

Unlike single-core voltage testers, dual core testers can recognize potential differences between any two points in an MV installation. Primarily reserved for conductors of the same phase (matching), they can also be used for dual core detection and for testing MV fuses.

CE



↔ Total length

mm Dimensions

kg Weight



TWO-POLE PHASE COMPARATOR FOR INDOOR AND OUTDOOR USE

Complete function testing: built-in, with TEST push-button (battery supplied).

Composition

- 2 elements connected by a high-insulation lead,
- 2 removable handles,
- metal case: 0.40 x 0.25 x 0.85 m.

Indications provided by the galvanometer needle; dials are calibrated according to voltage. High isolated materials characteristics.



CL-5-36 / CL-5-03

Reference	Graduation cadran (kV)		Type 6 LR-61	
CL-5-36	5 - 10 - 15 - 20 - 25 - 30 - 33 - 36	6 - 36 kV	9V	7.5
CL-5-03	0.750 - 1 - 1.25 - 1.5 - 3	0.75 - 3 kV	9V	

PERMANENT LUMINOUS INDICATOR FOR INDOOR USE

Single-pole 5 to 75 kV indicator. On bus bars. Rings with Ø 5 to 20 mm and planes 1 to 20 mm. Fixing on conductors. Signaling the presence of voltage by 7 electroluminescent diodes.

Reference	
CL-40010	Sold in box of 3 units

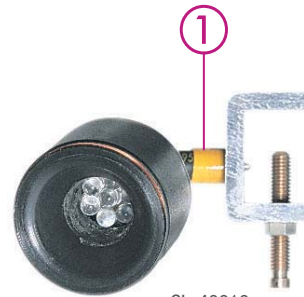

CL-40010

THE

- 1 Flexible stem for adjusting the orientation of the LEDs.

BIPOLAR VOLTAGE ABSENCE DETECTOR FOR CONTINUOUS CURRENT

The presence of voltage is indicated by:

- the lighting of 6 red LEDs + 1 blue polarity LED
- the activation of an audio signal (60 dBA / m²).

Continuous voltage absence detector from 100 to 30000V. Integrated device for ensuring the proper functioning of all the detector's functions. Delivered in a plastic case. High resistance body of the detector. 2 elements connected by a flexible, high insulation cable.

Reference			Type 6 LR-61	
CL6-100-30000	100-30 000 V	1.02 m	9V	1.5



INSTALLATION ON PERMANENT FIXED POINTS

3 contact clamps. 3 copper cables, IEC extra flexible silicone sheath, L = 1.5 m. Insulating stick. Earth clamp. 1 trifurcation connector earthed by an extra-flexible copper cable with silicone sheath, L = 2.5 m.

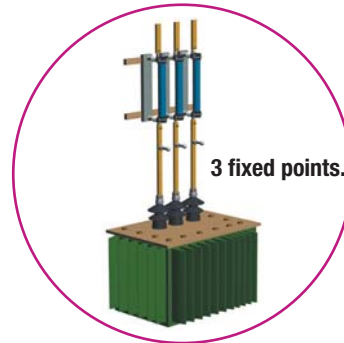

Reference	Rating (kA/1 s)	Installation on fixed points (mm)	Composition	Connection set
MT-1910	20	Ø 20 MT-2951 range	3 clamps MT-1911-E 1 MT-1911	3 cables 95 mm ² 1 earth cable 35 mm ²
MT-1920	30	Ø 25 MT-3951 range	3 clamps MT-1921-E 1 MT-1921	3 cables 150 mm ² 1 earth cable 50 mm ²

Fixed points
(characteristic page 160).



MT-2951



MT-3951



Plastic case.
M-78665

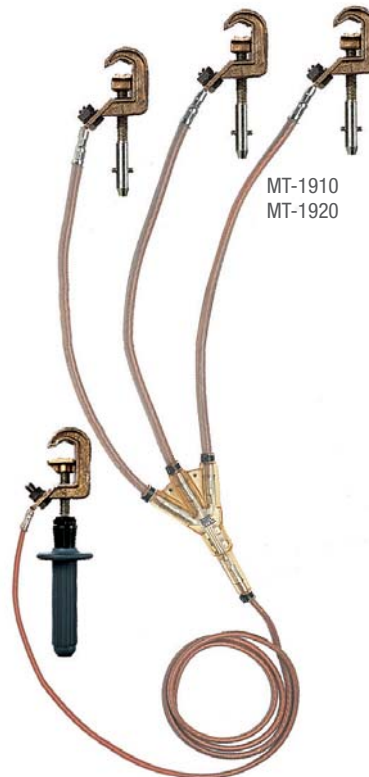

MT-1910
MT-1920



CF-5-40-E
Insulating stick to be
ordered separately.

IEC 61230



EARTH CLAMPS

Claw for "T" or round fixed points for round conductors.

Reference	Characteristic	Rating (kA/1 s)	kg
MT-1911-E	Claw for "T" fixed points Ø 20 mm round conductors Ø 8 to 18 mm	20	0.58
MT-1921-E	Claw for "T" fixed points Ø 25 mm round conductors Ø 10 to 25 mm	30	0.69
MT-1911	Same characteristics with handle MT-1911-E	20	-
MT-1921	Same characteristics with handle MT-1921-E	30	-
M-9573	Handle alone C end fitting	-	-



MT-1911-E
MT-1921-E



MT-1911
MT-1921

IEC 61230





INSTALLATION ON BARE CONDUCTORS

Contact clamps. 3 copper cable extra-flexible silicone sheath. L = 1.5 m. 1 trifurcation connector earthed by an extra-flexible copper cable with silicone sheath, L = 2.5 m. Earth clamp.

IEC 61230



Reference	Rating (kA/1 s)	Installation on fixed points	Composition	Connection set
MT-5805	20	<ul style="list-style-type: none"> • Ø 5-35 — 16-40 ┃ 5-40 	3 clamps MT-815-C 1 MT-840/1	3 cables 95 mm ² 1 earth cable 35 mm ²
MT-8408	12.5	<ul style="list-style-type: none"> • Ø 18-33 — — ┃ — 	3 clamps MT-814/3 1 MT-840/1	3 cables 70 mm ² 1 earth cable 35 mm ²
MT-9801	10	<ul style="list-style-type: none"> • Ø 5-16 — 0-16 • Ø 5-28 	3 clamps MT-817-C 3 clamps MT-814/2 1 MT-840/1	3 cables 50 mm ² 1 earth cable 25 mm ²

Delivered in case. Clamp characteristics : see page 159.

Installation on permanent fixed points:

Reference	Characteristic
MT-890	Clamps 3 claws
MT-891	Earth clamp fixation
MT-893	Cable tensioner
MT-895	Cable kit support
CI-06-D	Wall mounted support



MT-5805



CE-4-21-C
Insulating stick to be ordered separately.

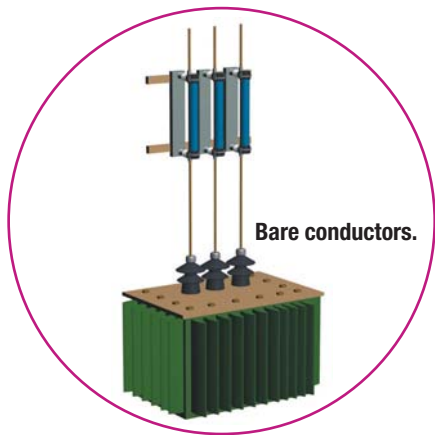

Bare conductors.



Plastic case included.
M-78665

CLAMPS FOR INSTALLATION ON BARE CONDUCTORS

Attachment (C-Type)

Hexagonal end-fitting. A circumferential braking system prevents the clamp from turning under the weight of the cable. Separate by simple pulling. Earth cable connection. With a crimped lug (12 mm Ø hole).

Material

Aluminium alloy except **MT-814/2** and **MT-814/3**: copper-aluminium bronze.

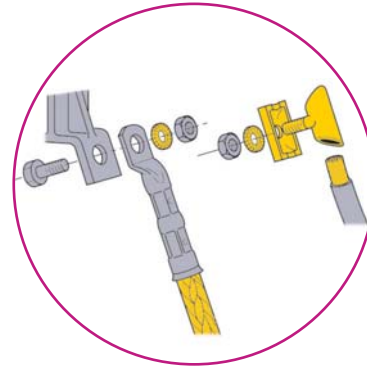

Recommended stick:

CE-4-21-C / CF-5-90-E / MG-115-S.

Reference	Rating (kA/1 s)	Dimensions (mm)	Ø (mm)	Weight (kg)
MT-811-C	21	35 x 77 x 157	• Ø 5-16	0.33
MT-812-C	21	35 x 79 x 143	• Ø 5-16 ■ 0-16	0.32
MT-813-C	21	35 x 79 x 169	■ 40 x 16	0.33
MT-814/2	14.5	85 x 56 x 192	• Ø 5-28	0.66
MT-817-C	21	30 x 90 x 140	• Ø 5-16 ■ 40 x 16	0.33
MT-814/3 *	14.5	85 x 56 x 195	• Ø 18-33	0.62
MT-818-C *	14.5	37 x 85 x 155	• Ø 10-32	0.44
MT-815-C **	30	44 x 100 x 180	• Ø 5-35	0.65
MT-815-E **	30	44 x 100 x 180	■ 16-40	0.65
MT-815-S **	30	44 x 100 x 180	■ 5-40	0.65

C



Hexagonal end-fitting. Rings with Ø 5 to 20 mm and planes 1 to 20 mm. Fixing on conductors.

E



Bayonet end-fitting.

S



Clamp stick mounting type.



MT-811-C



MT-812-C



MT-813-C



MT-814/2
MT-814/3



MT-815-C



MT-817-C



MT-818-C

EARTH CLAMPS

Copper aluminium bronze earth clamps.

Earth cable connection by connector, lug, TO- system...

Reference	Rating (kA/1 s)	Dimensions (mm)	Connection	Clamp capacity (mm)	Weight (kg)
MT-840	20	40 x 73 x 135	TO-08 connector 35 mm ²	• Ø 6 - 25 ■ 0 - 25	0.48
MT-840/1	20	40 x 73 x 135	Thread: Ø 12.5 mm	• Ø 6 - 25 ■ 0 - 25	0.48
MT-841	30	40 x 73 x 135	Connect. Fontenay ≤ 50 mm ²	• Ø 6 - 25 ■ 0 - 30	0.48



MT-840



MT-840/1



MT-841

Dimensions (mm) Diameter (mm) Clamp capacity (mm) Weight (kg)



FIXED POINTS FOR PERMANENT PLACEMENT

The advantages of grounding and short circuiting using permanently installed fixed points on existing conductors include:

- Using the same grounding and short circuiting equipment regardless of the conductor shape, section, or configuration.
- Accessibility from variable angles.
- Eliminating the risk of errors because grounding locations appear at first glance.

Reference	Rating (kA/1 s)	Sphere dimension Ø	Fixing	Conductors	kg
MT-951/1	10	18 mm	Bolt: M 10 - L = 25 mm	Flat conductors	0.09
MT-951/2			Bolt: M 10 - L = 35 mm		0.10
MT-951/3			Bolt: M 10 - L = 45 mm		0.10
MT-952/1			Bolt: M 10 - L = 25 mm		0.11
MT-952/2			Bolt: M 10 - L = 35 mm		0.12
MT-952/3			Bolt: M 10 - L = 45 mm		0.13
MT-953/08			Ø 6-8	Round conductors	0.13
MT-953/12			Ø 10-12		0.18
MT-955/08			Ø 6-8		0.15
MT-955/12			Ø 10-12		0.20
MT-956	Thread: Ø 12.5 mm		Terminal fitting	0.75	
MT-2951	20	20 mm	Taraudage : M 12	-	0.13
MT-2951/1			Bolt: M 12 - L = 35 mm		0.18
MT-2951/2			Bolt: M 12 - L = 45 mm		0.20
MT-2950/35			Bolt: M 12 - L = 45 mm		0.24
MT-3951	30	25 mm	Bolt: M 12	-	0.24
MT-3952			Bolt: M 16		0.24
MT-3951/1			Bolt: M 12 - L = 45 mm		0.30
MT-3952/1			Bolt: M 16 - L = 45 mm		0.35
MT-3950/35			Bolt: M 12 - L = 35 mm		0.30



MT-2951
MT-3951
MT-3952

MT-2950/35
MT-3950/35

MT-2951/1
MT-2951/2
MT-3951/1
MT-3952/1

ACCESS POINTS

To be used with clamps type MT-1911, MT-1921.

Reference	Rating (kA/1 s)	Fixing	kg
MT-1951/10	20	Bolt: M 10 - L = 35 mm	0.12
MT-1951/12	20	Bolt: M 12 - L = 35 mm	0.12

Clamps

Reference	Rating (kA/1 s)	Fixing	kg
MT-920-E	20	For fixed points Ø 20 mm	0.35
MT-925-E	20	For fixed points Ø 25 mm	0.40



MT-1951/10
MT-1951/12



MT-920-E

INSULATING STICKS FOR SUBSTATION USE

Short circuiting and earthing systems for substation.
Telescopic sticks for voltage detectors and earthing systems for use in dry and wet conditions.

Reference	~	Ø mm	Folded	Unfolded length	kg
CE-3-24-C	36 kV	Ø 32/27.5	0.56 m	0.80 m	0.37
CE-75-(**)	75 kV	41/32	1.15 m	2 m	2
CE-4-21-(*)	90 kV	41/32	1.15 m	2 m	1.5
CE-4-30-C	150 kV	41/32	1.75 m	3 m	2
GM-7-10-A	Extension	36	-	1 m	1

(*) Specify type of mounting when ordering : C, K or E.

(**) Specify type of mounting when ordering : C or K.

Reference	~	Ø mm	Folded	Unfolded length	kg
CE-5-105-X	220 kV	63.5/27.5	1.66 m	10.75 m	5.4
CE-5-90-X	220 kV	57.5/27.5	1.61 m	9.25 m	4.2
CE-5-70-X	220 kV	52.5/27.5	1.56 m	7.8 m	3.3
CE-5-60-X	220 kV	47.5/27.5	1.51 m	6.4 m	2.5
CE-5-50-X	220 kV	42.5/27.5	1.46 m	5 m	1.9

X : Specify type of mounting when ordering.

(K : universal ; C : hexagonal, 12 mm on flat surfaces)

THE +

- CE-4-21-(*) et CE-4-30-C** : Certified telescopic rod IEC 62193 (2003) and IEC 61235. Hand shield.
CE-75-(*) : Certified telescopic rod IEC 62193 (2003) and tube IEC 60855-1.
CE-75-C : EDF authorisation: 18-130 B
- CE-5-(**)** : Certified telescopic rod IEC 61235.

STANDARD STICKS

For short circuiting and earthing system.
For use in dry conditions.

Reference	~	Ø mm	↔	kg
CF-3-72...-(*)	72.5 kV	36	1.50 m	0.88
CF-3-90...-(*)	90 kV	36	2 m	1.06

(*) Specify type of mounting when ordering : C, K or E.
Delivered with wall mounting CI-10-D

STICKS WITH SKIRTS

For short circuiting and earthing system.
Epoxy resin / fiberglass composite tubes on foam
Polyurethane. With polycarbonate insulating skirt Ø 100mm,
Height 90mm, impact resistant. Use in rain.

Reference	~	Ø mm	↔	kg
CF-5-40-(*)	40 kV	36	1.50 m	1.15
CF-5-90-(*)	90 kV	36	2 m	1.55

(*) Specify type of mounting when ordering : C, K or E.

An upper orange element made of glass fiber/resin epoxy foam filled of 32 mm diameter (**).

Insulating skirts polycarbonate, shock resistant.



Ø mm Diameter ↔ Total length □ mm Dimensions 📦 Weight



STATIC DISCHARGE STICK

Field of use :

Medium voltage static ground discharger.

Characteristics :

- For use on medium voltage lines up to : 33 kV.
- Insulating orange tube Ø 39 mm made of epoxy fiberglass and in accordance with IEC 60855 standard.
- Equipped with 6 m of copper cable, section 6 mm², PVC insulated.
- Hand guard at length 0.65 m.
- Copper alloy contact probe, length : 80 mm.

Reference		mm	
CM-50	33 kV	1.6 m	2.3



Examples of possible compositions:

Residual voltage discharge rod

Bag CM-1-15 + telescopic stick CE-4-21-C + 35 mm² Copper cable and length 5 m with silicon coating: M-2435SX5 + MCC35 + FM DIRECTE + insulated clamps MC-132-D on one side

Static discharge stick

Hook CM-05-K + Copper cable 16 mm² with silicon sheath, Length 2 m, crimped lugs at both end + Earth clamp MT-840/1, capacity round 0 to 25 mm and flat 0 to 25 mm + Insulating stick CF-5-40-K length 1.5 m.



IEC 61230



We can deliver complete set with foot capacitance, head capacitance and wirings to your own specifications. Please consult us.





INTEGRATED VOLTAGE PRESENCE INDICATING SYSTEM (V.P.I.S)

IEC 61958

Indicates the voltage presence on M.V. cubicles by being installed on the capacitive dividers. Voltage of use behind capacitive dividers: 1 000 V (between phase and neutral). Light threshold: 90 V. Signaling: 3 neons. Attachment: male/female plugs. Sound phase comparator. **MX-404**.





Reference	Characteristics	 mm	 kg
CL-495-3	Delivered complete with connector assembly	130 x 30	0.85

INTEGRATED VOLTAGE DETECTING SYSTEM (V.D.S)

IEC 61243-5

Indicates the voltage presence on M.V. cubicles by being installed on the capacitive dividers. Voltage of use behind capacitive dividers: 1 000 V (between phase and earth). Light threshold: 70/90 V. Input impedance: 36 MΩ. Signalling by 3 red diodes. Sound phase comparator.





Reference	Characteristics	 mm	 kg
CL-497-00	Delivered complete with connector assembly	146 x 30	0.90

SOUND PHASE COMPARATOR***

The MX-404 sound phase comparator checks the concordance between 2 phases. The comparator's operation is indicated by: Emission of an audible signal when there is discrepancy between the two phases. Absence of an audible signal when there is no discrepancy between the two phases. Power supply: 9 V type 6LR battery.



Reference	Characteristics	 mm	 Type 6 LR-61
MX-404 ***	Delivered with case	145 x 80	0.90

*** This comparator does not work on Schneider electric cells V2 type.

 Diameter  Total length  Dimensions  Weight





INTERFACE FOR INTEGRATED VOLTAGE DETECTING SYSTEM (V.D.S)

*IEC 61243-5



Indicates the voltage presence on M.V cubicles by being installed on the capacitive dividers. For High impedance detecting systems Input impedance: 36/43 MV. Voltage indication by 4 mm standard sockets on the front of the indicator. Voltage indicator by 4 mm standard socket.



Reference	Characteristics	mm	kg
CL-498-00*	Delivered with connection set	146 x 30	90

SEPARABLE VOLTAGE DETECTING SYSTEM (V.D.S)

This device enables to check the absence or presence of voltage on three phases (L1, L2, L3). HR high impedance. Voltage max: 1 080 V rms. 50/60 Hz. Voltage presence: **RED** flashing LED > 1 Hz. Fits in CL-498 devices.



Reference	Characteristics	mm
CL-499/101	Delivered in plastic bag	145 x 80

VOLTAGE TESTER FOR M.V. SEPARABLE CONNECTORS 10-36 KV



Checks the absence of voltage on the capacitive terminals of plug-in M.V. bushings. Sensor in the form of a bent finger enabling removal and reinstallation of the terminal insulating cover. For a nominal voltage from 10 to 36 kV. Signal via beeping and bright red flashing of electro-luminescent diodes. Built-in function test via the "TEST" button which covers the entire device. Permanent stand-by state. Power supply: four 1.5 V, R-6 batteries. Mounting on insulating stick via a universal end.



Reference	Characteristics	kg
CC-151-K	Tester in rigid case with batteries 70 x 100 x 165 mm	0.70
CC-45-K	Stick to use with the CC-151K. L = 1.25 m	0.60
CI-06-D	Wall mounted supports	-

SAFETY LAMPS

Compatible with **NF C 13-100**.

Reference	Characteristics	 mm	 kg
CD-128	2 operating modes: BAPI (factory setting) or BAES (automatic mode is triggered during power cut) 1 LED 1W white Autonomy 1 H to 3 H depending on the position of the switch 45 lm / 3 H: 1st support / 100 lm / 1 H: 2nd support In compliance with the standard BAPI NFC 71810 Battery Ni Cd 1 battery 2.4V 1.5Ah - Power supply 230V - 50 / 60HZ Operating Temperature 0 °C to + 40 °C Protection indices IP42 and IK10 I - Class II	240 x 138 x 60	0.68
CD-124	Delivered with a wall mounted support. Operates: 1 hour (12 W), 2 hours (6 W) Rechargeable on 230 V 50/60 Hz	100 x 190 x 220	1.9

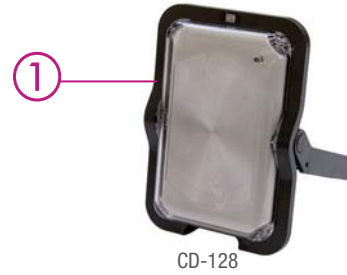



THE

1 100% LED - up to 3 hours of battery life - Small and very light - Adjustable handle.

MANŒUVERING AND RESCUE STICKS

White resin polyester/glass fiber foam filled tube.

Reference			
CM-45	45 kV	1.50 m	7.50
CS-45 *	45 kV	1.65 m	1.00
CM-90	90 kV	1.85 m	0.80
CS-90 *	90 kV	2.05 m	1.10
CM-225	225 kV	2.25 m	0.85
CS-225 *	225 kV	2.45 m	1.35

* Delivered complete with non-removable hook and wall supports.
Cannot be used in rain.

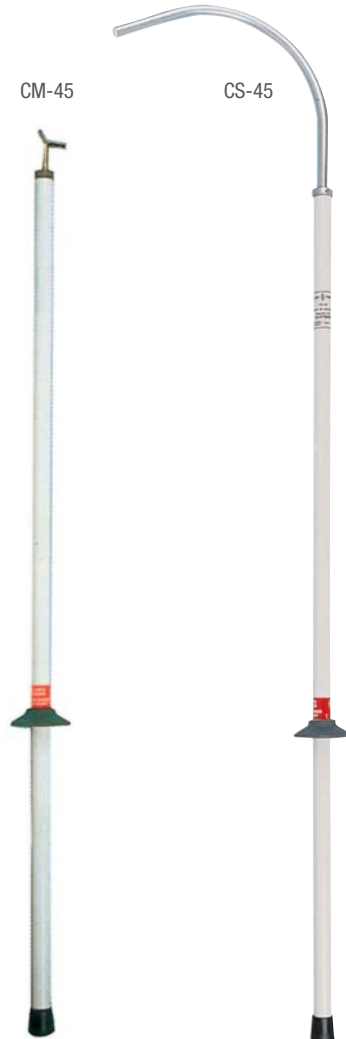

APERTURE HOUSING

Compatible with NF C 13-100.

Moulded plastic. Installed outside by tightening three screws on a steel clamp.

Reference	Passage	
CI-70	60 mm	0.14



 Dimensions  Weight  Total length





LIFE SAVING KITS FOR M.V. SUBSTATIONS

Complete equipment allowing intervention on victims in case of an electrical hazard. Delivered in a plastic box with transparent cover for immediate visualization of contents and wall mounting kit.

Composition :

- Insulated cable cutter. Forged steel blades. Maximum opening 30 mm. (CZ-60)
- Insulating platform 24 or 36 kV. (CT-7-25/1)
- Rescue telescopic stick. (M952160)
- Voltage detector with flexible antenna contact (with autotest). (M952170)
- Safety instructions on the plastic board. (CG-3-10-NR/CZ-54)
- High voltage insulating gloves, talcum powder can. (CG-4-10-NR/CZ-55) - (CG-3-10-NR/CZ-54)
- Insulating boots. (MV-137-45)
- Wall mounted cabinet.



Reference	Characteristics			
CZ-54-R	English instructions	24 kV	840 x 754 x 270 mm	21
CZ-54-RM	English/Arabic instructions	24 kV	840 x 754 x 270 mm	21
CZ-55-R	English instructions	36 kV	840 x 754 x 270 mm	21
CZ-55-RM	English/Arabic instructions	36 kV	840 x 754 x 270 mm	21

THE

- 1 Emergency supplies at your fingertips.
- 2 Protection against dust and shock.

INFO

In case of an electrical accident, quick action is essential: by saving seconds, you get more chance to save life. Our life saving equipment is designed to make all necessary equipment immediately available to rescue people.

INSULATED CABLE CUTTER

Insulated handles 25 kV.
 Maxi cable : 30 mm.
 Section ≈ 150 mm².
 Maximum opening: 30 mm.

Reference		
CZ-60	0.630 m	2.2



WALL MOUNTED SUPPORTS

For sticks and voltage detectors. Plastic.

Reference	∅ mm	Top	∅ mm	Bottom
CI-06-D		28-30		36 max.
CI-08		16-20		36 max.
CI-10-D		32-36		58 max.
CI-12-D		28-30		58 max.



RESCUE HOOK

On stick equipped with a "C" end-fitting. Delivered with wall mounted supports.

Reference	Characteristics	mm	kg
CS-01-C	Adaptor C	345 x 335	0.35



COMPACT CARRYING KIT

This compact kit is designed especially to be carried in a vehicle for safety electrical intervention. Made of two parts of moulded material (PEHD), the red case cover is also an insulating platform.

Composition :

- Insulated cutter cable.
- Adhesive tape (black and yellow). L = 100 m.
- Telescopic insulating stick. L = 1.5 m.
- Talcum powder can.
- Pair of insulating boots.
- Voltage detector with autotest. Rescue hook. (127 V - 90 kV alternatif)
- Pair of insulating gloves with reinforced carrying bag.
- Safety instructions and safety first aid posters.
- Insulating platform.

Reference	Characteristics with instructions in English	~	mm	kg
CZ-53-R	With instructions in English	25 kV	710 x 570 x 240	21
CZ-53-MR	With instructions in English/Arabic	25 kV	710 x 570 x 240	21
CZ-53-R/2	With instructions in English	36 kV	710 x 570 x 240	21
CZ-53-MR/2	With instructions in English/Arabic	36 kV	710 x 570 x 240	21

THE

1 Stability of the suitcase when stored vertically or horizontally.



∅ Diameter ← Total length mm Dimensions Weight

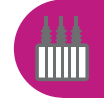

OIL & GAS

Offshore installations, shipbuilding,
heavy industry



The world of electrical safety



**Your major supplier for
all your electrical safety equipment needs**

Just contact us !

CATU™

Medium voltage equipment

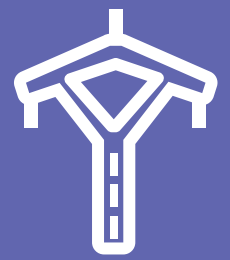

<u>IEC voltage detectors</u>	170
<u>Voltage detectors</u>	171
<u>Single phase comparators</u>	172
<u>IEC equipment</u>	173
<u>Insulating sticks</u>	174
<u>Clamp dispenser and accessories</u>	177
<u>Overhead line systems</u>	178
<u>Cables</u>	179
<u>Underground systems</u>	181
<u>Sticks accessories</u>	182
<u>Storage and maintenance products</u>	183





IEC ELECTRONIC VOLTAGE DETECTORS, "COMPACT SERIE" FOR INDOOR AND OUTDOOR USE

IEC 61243-1
CE

Ultimate technology of voltage detector "Head Capacitive Technology"

Compact and light, it offers a wide band (10/36 kV).

Operating check :

By pressing the TEST button:

- A RED LED flashes on.
- Powerful rated audible signal > 60 dB(A)/2 m.
- When loosening the button, the timed GREEN LED lights up.

While remaining on, it indicates the good working order of the detector.

Characteristics :

- Precise and stable operating threshold.
- High environmental resistance (impacts, vibrations, moisture).
- Temperature conditions: class N (IEC 61243-1 standard).
- Use from 50 to 60 Hz.

Composition :

- Robust housing.
- Weight of the detector: 350 gr.
- Size of the detector: Ø 59 x 270 mm.



Reference		Operating voltage (KV)		
			Type 6 LR-61	kg
CC-765-55/20*	50/60 Hz	5,5 - 20 kV	9 V	0.35
CC-765-3/10*	50/60 Hz	3 - 10 kV	9 V	0.35
CC-765-10/36*	50/60 Hz	10 - 36 kV	9 V	0.35
CC-765-10/30*	50/60 Hz	10 - 30 kV	9 V	0.35

(*) Specify type of mounting when ordering: C or K.

Packaging : unit supplied complete in a case with batteries and contact electrodes (straight and V-shaped).

For other voltages, please consult us.

Voltage presence is indicated by:

- RED flashing LED (very bright -visible at more than 20 m in direct lighting),
- powerful rated audible signal > 60 dB(A)/2 m.

THE

1 Light indication 360° visibility.

NEW Dual voltage range detector : CC-775.
This voltage detector is also available with two voltage ranges without a manual selector switch, in compliance with the standard IEC 61243-1.
Example: from 2 to 7 kV & from 12 to 25 kV.
Please contact us in order to determine together your appropriate need in the respect of the standard.



End fittings:

C : hexagonal 12 mm, for hexagonal end-fitting sticks, K: universal, for universal end-fitting sticks.
 Recommended stick: **CE-4-21**, **CE-75**.

STANDARD ELECTRONIC VOLTAGE DETECTOR FOR INDOOR AND OUTDOOR USE

C 18-311
CE

Checking

By pressing the test button :

- extremely bright **RED** flashing LED's (visible at more than 50 meters even in unfavourable light),
- powerful rated audible signal > 60 dB/2 m



The test button is released :

- a timed **GREEN** LED lights.

Indicating both the detector is operational and the self testing of the unit continues.

Characteristics :

- Precise and stable operating threshold.
- High environmental resistance (impacts, vibrations, moisture).

Reference		Operating voltage	 Type 6 LR-61	
CC-365-3/10-(*)	50 Hz	3-10 kV	1.5 V	0.50
CC-365-10/30-(*)	50 Hz	10-30 kV	1.5 V	0.50

(* Specify type of mounting when ordering: C or K.
Packaging : unit supplied complete in a case with batteries and contact electrodes (straight and V-shaped).
Total weight : 1100 g, Total size : 340 x 275 x 83 mm.
For other voltages, please consult us.

Accessories :

Reference	Characteristics
CC-365-101	Flag/Vee contact electrode
C-92-492	Contact electrode for installations L = 310 mm, insulating on 300 mm

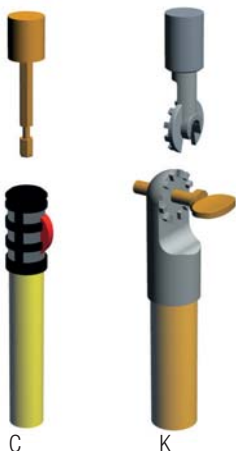

End fittings:

C : hexagonal 12 mm, for hexagonal end-fitting sticks, K: universal, for universal end-fitting sticks.
Recommended stick: **CE-4-21**, **CE-75**.



CC-365-K



CC-365-C

GREEN LED



Double signaling:

- Voltage presence is indicated by both:
- extremely bright **RED** flashing LED's (visible at more than 50 meters even in unfavourable light),
 - powerful rated audible signal > 60 dB/2 m.





SINGLE POLE PHASE COMPARATOR FOR INDOOR AND OUTDOOR USES

IEC 61481
CE





Unipolar device used to check phase concordance in 2 steps.

- Step 1: storage of the reference phase.
- Step 2: search for the phase in concordance with the one memorised in step 1.

The operator has 15 seconds to complete step 2.

After this time, step 1 must be started again.

To be used on 50 and 60 Hz networks.

Reference		 Type LF 22	 aerial	 kg
CL-7-06/18-(*)	6-18 kV	9 V	0.55 m	0.85
CL-7-10/30-(*)	10-30 kV	9 V	0.90 m	0.90
CL-7-10/30-1-(*)	10-30 kV	9 V	1.15 m	0.95
CL-7-12/36-(*)	12-36 kV	9 V	0.90 m	0.90

(*) Please specify type C or K when ordering.
Delivered in carrying case.



Fixation C or K.

GREEN LED = phasing indication.

ORANGE LED = memorized phase status voltage are in memory.

RED LED = non-phasing indication.

Press the button to test the device and to reset its memory.



IEC SHORT-CIRCUITING AND EARTHING SYSTEMS (THREE-PHASE CROSSARM NETWORKS)

MT-613 clamps are automatic contact clamps. They are put into position from above the conductor, using the clamp dispenser head MT-635/1-C.

Reference	Equipment composition
MT-6613	3 automatic contact clamps MT-613 Connection cables 35 mm ² , max. gap between clamps: 2.75 m 1 clamp dispenser head MT-635/1-C 1 spool with earthing cable connection MT-640-S 1 carrying bag M-87295
MT-6613/1	3 automatic contact clamps MT-613 Connection cables 95 mm ² , max. gap between clamps: 3 m 1 clamp dispenser head MT-635/1-C 1 earthing cable connection 15 m x 35 mm ² 1 earthing clamp MT-840/1 1 carrying bag M-87295

Reference	Rating (kA/1 s)	Connection copper cable between clamps (mm ²)	Earth connection copper cable (mm ²)	∅ mm conductor
MT-6613 *	8	35	16	5 to 30
MT-6613/1 **	17.5	95	35	5 to 30

* Recommended sticks: CE-4-21-C.
** Recommended sticks: CM-4, CF-5, CM-7 et CM-4000.

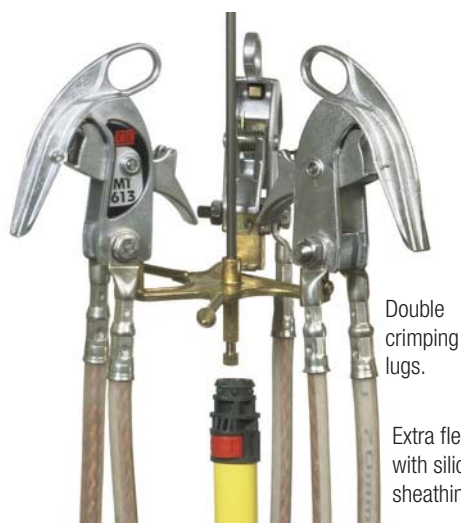
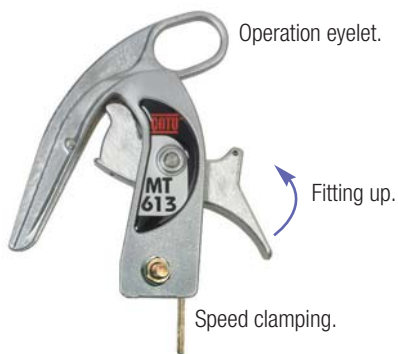

Double crimping lugs.

Extra flexible cable with silicone sheathing.

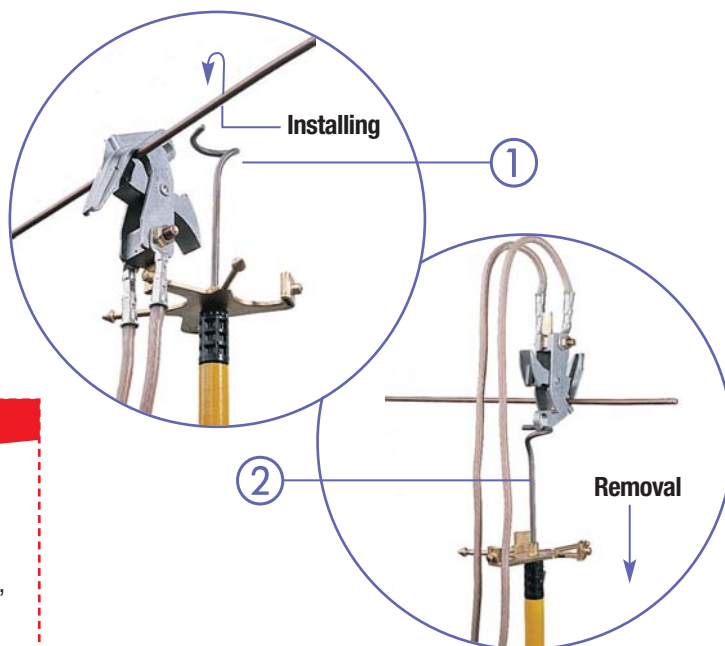

THE +

- 1 Remarkable rapidity and ease of handling.
- 2 Removal is carried out by pulling down the clamp, which revolves around the conductor by means of the pig tail fixed in the centre of the clamp dispenser head.

IEC 61230





TELESCOPIC STICKS FOR VOLTAGE DETECTOR

Suitable for wet conditions.

Reference	~	∅ mm	Folded up	↔	kg
CE-4-21-(*)	90 kV	41/32	1.15 m	2 m	1.5
CE-4-30-C	150 kV	41/32	1.75 m	3 m	2
CM-7-10-A	Extension*	36	-	1 m	1
CE-75-(*)	75 kV	41/32	1.15 m	2 m	2

(*) Please specify type C, K and E when ordering.
Delivered with wall mounted supports CI-10-D.
* For CE-4-21.

Reference	~	∅ mm	Folded up	↔	kg
CE-5-105-X	220 kV	63.5/27.5	1.66 m	10/75 m	5.4
CE-5-90-X	220 kV	57.5/27.5	1.61 m	9.25 m	4.2
CE-5-70-X	220 kV	52.5/27.5	1.56 m	7.8 m	3.3
CE-5-60-X	220 kV	47.5/27.5	1.51 m	6.4 m	2.5
CE-5-50-X	220 kV	42.5/27.5	1.46 m	5 m	1.9

X : Please specify type C or K when ordering.

THE ⊕

- 1 CE-4-21-(*) and CE-4-30-C : Certified IEC 62193 (2003) and IEC 61235. Hand shield.
- CE-75-(*) : Certified IEC 62193 (2003) and IEC 60855-1.
- E-75-C : EDF authorisation: 18-130 B

FIXED LENGTH STICKS

Suitable for wet conditions.

Reference	~	↔	∅ mm	Skirt nbr	kg
CF-5-40-(*)	40 kV	1.50 m	36	1	1.15
CF-5-90-(*)	90 kV	2 m	36	1	1.55
CF-5-110-(*)	110 kV	2.50 m	36	2	2
CF-5-170-(*)	170 kV	3 m	36	3	2.4

(*) Please specify type C, K or E when ordering.

THE ⊕

- 1 CF-5 : Insulating skirts (∅ 100 mm, H90 mm) for use in rain.

WALL MOUNTED SUPPORTS

For sticks and voltage detectors. Plastic.

Reference	Top ∅ mm	Bottom ∅ mm
CI-06-D	28-30	36 max
CI-10-D	32-36	58 max
CI-12-D	28-30	56 max
CI-08	16-20	36 max

An upper orange element made of glass fiber/resin epoxy foam filled of 32 mm diameter.

Isolated skirts polycarbonate ∅ 100 mm, height 90 mm, Shock resistant.



Hand guard.

Element made of resin polyester/glass fiber.

CE-4-21-C
CE-4-30-C

CM-7-10-A

CE-75-C

CE-5

Series CF-5

Top

Bottom



INSULATING STICKS FOR SHORT-CIRCUITING AND EARTHING SYSTEMS

This range allows a stick-length limitation in case of space requirements and carrying capabilities.

For common applications a serie of complete sets including 2 or 3 elements are made to give simple solutions for working distance from 2 to 6 meters.

	Reference	smallest end fitting	biggest end fitting	isolation	kg
Basic	CM-4410	1.13 m	–	0.12 m	1.25
	CM-4415	1.63 m	–	0.38 m	1.70
	CM-4420	2.13 m	–	0.38 m	2.70
	CM-4425	2.63 m	–	0.88 m	3.20
Intermediate	CM-4410-I	1.165 m	–	0.80 m	1.20
	CM-4415-I	1.665 m	–	1.30 m	1.60
	CM-4420-I	2.165 m	–	1.80 m	2.50
	CM-4425-I	2.665 m	–	2.30 m	3.00
Terminal	CM-4410-(*)	1.115 m	1.21 m	0.70 m	0.90
	CM-4415-(*)	1.615 m	1.71 m	1.20 m	1.30
	CM-4420-(*)	2.115 m	2.21 m	1.70 m	2.10
	CM-4425-(*)	2.615 m	2.71 m	2.20 m	2.60

(*) Add end-fitting: B-C-E-H-K-T-D

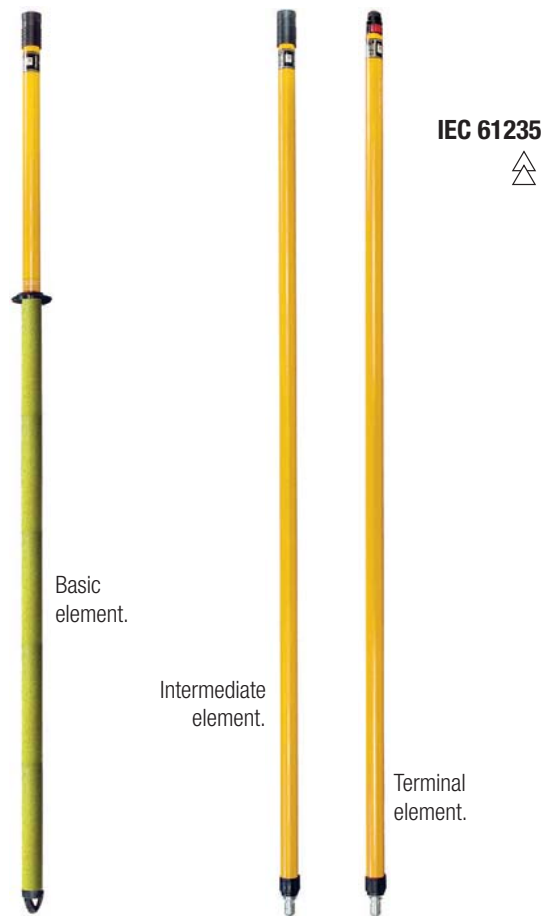

IEC 61235



Example of assembly



INTERMEDIATE ELEMENTS WITH RAIN SKIRTS

Intermediary element with skirt, which can be located on all the references mentioned above.

Reference	smallest end fitting	kg
CM-4400-J	0.362 m	0.95



INSULATING STICK BAGS

Strong waterproof canvas cases with a heavy duty zipper closure. Shoulder strap. Transparent plastic window for inspection.

CM-1-(*) : For 1 to 3 poles.

CM-3-(*) : For elements series CM-6. For 5 simple elements or 4 double elements.

Reference	Dimensions mm
CM-1-10	1.30 m length
CM-1-15	1.80 m length
CM-1-20	2.40 m length
CM-3-03	0.575 x 1.950 (elmt 1.75 m length)
CM-3-04	0.575 x 2.450 (elmt 2 m length)
CM-3-05	0.575 x 2.850 (elmt 2.50 m length)
CM-3-06	0.575 x 3.400 (elmt 3 m length)



↔ Total length

mm Dimensions

kg Weight

mm Diameter



CONNECTION ADAPTORS FOR INSULATING STICKS

	<p>C</p> <p>Hexagonal femal 6 sides</p>		<p>K</p> <p>Universal</p>		<p>E</p> <p>Bayonet</p>		<p>S</p> <p>Clamp stick</p>		<p>A ou B</p> <p>21</p> <p>For stick CM-4 / CM-6 / CM-7.</p>		<p>*</p>		<p>H</p> <p>26</p>		
Accessories	<p>C</p>				<p>K</p>				<p>E</p>		<p>*</p>		<p>H</p>		
Connection adaptors	CI-7-C	CI-3-C	CI-6-C2	CI-5-C	CI-3-K	CI-4-K	CI-6-K	CI-7-K	CI-5-K	CI-3-E	CI-7-E	CI-4-E	CI-D-K	CI-6-H	CI-3-H
Sticks	E	AB	K	S	AB	C	K	E	S	AB	K	C	K	K	AB

With this range any accessory can be attached to any stick by using connection adaptors. Other models, please consult us.

CLAMP DISPENSER HEADS

Copper aluminium alloy.

For MT-613/1 and 613/2 clamps

Reference	Head for 3 clamps	Head for 4 clamps	With pigtail hook
MT-630-C	■		
MT-630-K	■		
MT-630-S	■		
MT-635/1-C/K/S	■		■
MT-634-C/K		■	

For MT-613/1 and 613/2 clamps

Reference	Head for 3 clamps	Head for 4 clamps	With pigtail hook
MT-633-C	■		■
MT-633-K	■		■
MT-633-S	■		■
MT-634/1-C/K		■	■

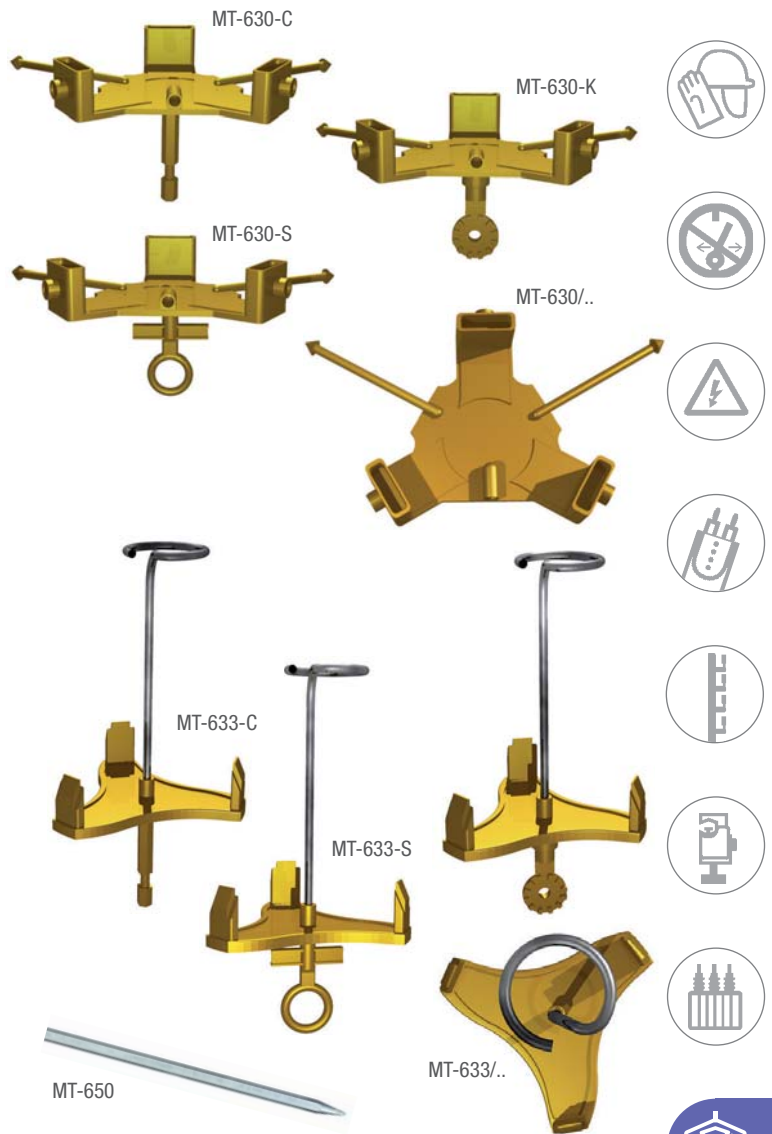

EARTH ROD

Reference	Characteristics	↔
MT-650	Hexagonal section rod	1 m

EARTH CLAMP

Copper aluminium bronze earth clamps.

Reference	Icc (kA/1 s)	Conductors (mm)	g
MT-840/1	20	∅ 6-25 0-25	480
MT-843	40	∅ 6-35 0-35	950



SPOOL WITH EARTHING CONNECTION

Spool with cable and earth clamp.

Reference	Silicone cable (mm ²)	↔
MT-640-S	16	16 m
MT-641-S	16	25 m



IEC 61230





SHORT-CIRCUITING AND EARTHING SYSTEMS

Installed from the ground on conductors up to 10.50 m.
Easier installation features.

Re-inforced insulating stick (36 mm dia.).

Self locking contact clamp: powerful conductor clamping and very good performance at short-circuiting, does not slide.

More rigid metallic stick. Lower tube 30.6 mm dia.

Upper tube 16 mm dia.

Re-inforced insulating stick (36 mm dia.).

On all models: Reinforced insulating pole: Epoxy/fibreglass resin over Ø 36 mm PV foam with a non-skid area.

This equipment can be used for rigid deployed poles for easy installation.

Reference	Rating (kA/1 s)	Ø mm conductor
MT-508/36	8	3-22
MT-508/46	8	3-22

Reference	Composition
MT-508/36	3 telescopic metallic sticks 3 elements L = 6.00/2.37 m - 2.4 kg - MT-512/36 1 insulating stick 2 elements 1.65 m - MT-531 Reel for 3 cables 10 m x 35 mm ² with earth connect. for attachment to stick - MT-543/35 1 earth rod 1 m - MT-650 1 bag 2.50 x 0.30 x 0.15 - 10.5 kg -M-87-127
MT-508/46	3 telescopic metallic sticks 4 elements L = 5.10/1.62 m - 2.1 kg - MT-512/46 1 insulating stick 2 elements 1.65 m - MT-531 1 insulating intermediate stick element 1.65 m - CM-4-165-B 1 stick lifter - MT-546 Reel for 3 cables 10 m x 35 mm ² with earth connect. for attachment to stick - MT-543/35 1 earth rod 1 m - MT-650 1 bag M-87-208

Equipment available in retail sale.

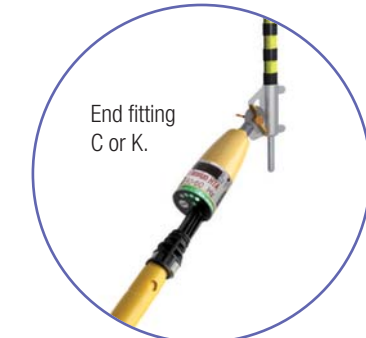
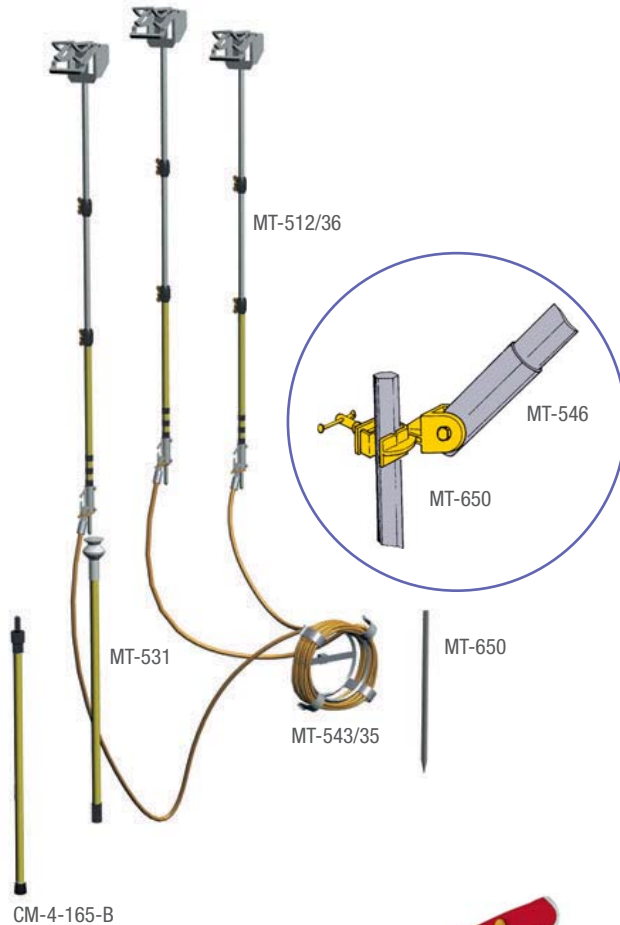

THE ⊕

- 1 Installation from the ground.
- 2 Self-locking contact clamp.

COPPER CABLES

Extra flexible braided multi-strand copper cables. Delivered to the meter with a minimum of 5 meters. Available in vinyl (A) or silicone sheath (B).

* IEC 61230



Reference		Rating (kA/1 s)	Cable		Section (mm ²)
A	B*		Weight (kg/m)	Ø (mm)	
M-24-10	-	2	0.105	4.5	10
M-24-16	M-24-16-S	4	0.156	5.6	16
M-24-25	M-24-25-S	6	0.275	7.5	25
M-24-35	M-24-35-S	8	0.386	9	35
M-24-40	M-24-40-S	10	0.440	9.5	40
M-24-50	M-24-50-S	12	0.545	10	50
M-24-70	M-24-70-S	16	0.768	12	70
M-24-95	M-24-95-S	20	1.000	14	95
M-24-120	M-24-120-S	30	1.280	17	120
M-24-150	M-24-150-S	40	1.630	19	150



THE +

- 1 Silicon sheath certified IEC 61230 offering more flexibility for better comfort of use.

Copper cables only: Heating curves (Gut & Grundberg method).

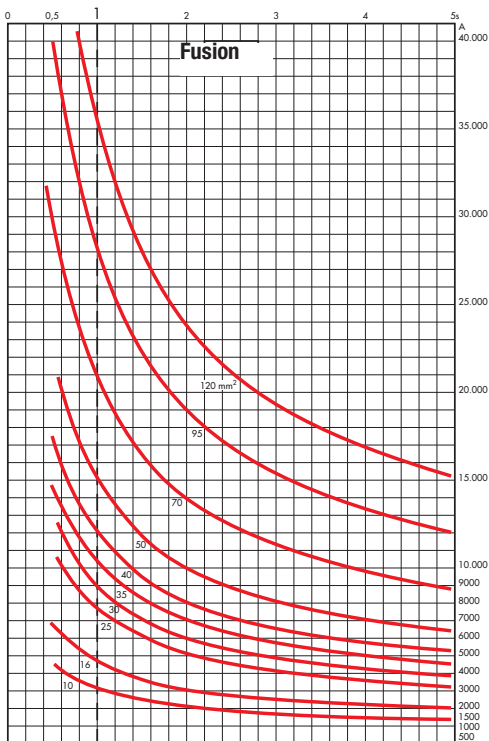

Copper cables only: Heating curves - 300 °C.

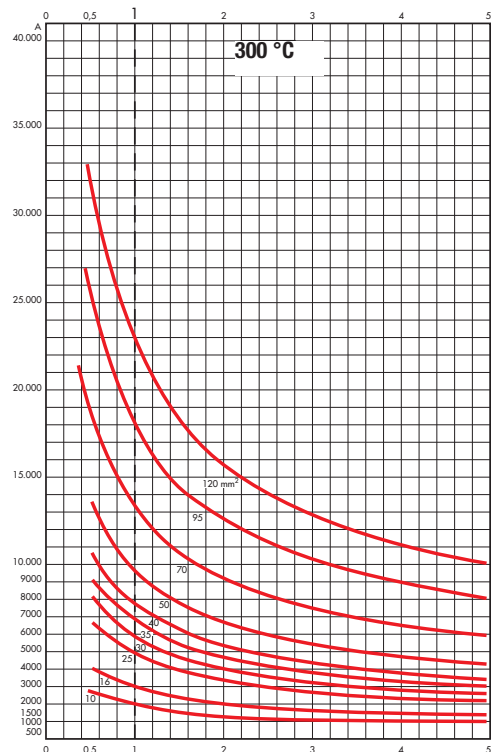



ALUMINIUM CABLES

Extra flexible braided multi-strand cables.
Transparent PVC sheath, with cable section identification.

Reference	Rating (kA/1 s)	Cable		Section (mm ²)
		Weight (kg/m)	Ø (mm)	
M-28-50	7	0.170	11.5	50
M-28-70	10	0.240	13.4	70
M-28-120	17.5	0.430	19	120
M-28-150	20	0.510	21	150

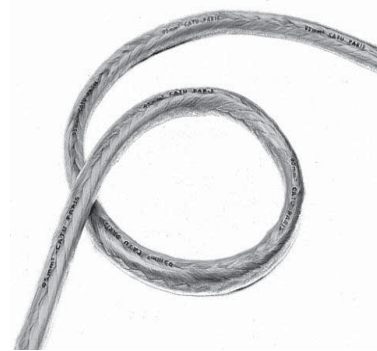

JUMPER CABLES SPECIALLY MANUFACTURED ITEMS

Assembly consisting of three copper cables or braids for short circuiting, connected to a copper ground wire through a trifurcating box. Transparent PVC sheath.

Reference	Characteristics	Rating (kA/1 s)	kg
MT-40	3 cables 40 mm ² - L = 0.75 m 1 earth cable 40 mm ² - L = 2 m	10	2.3
MT-70/1	3 cables 70 mm ² with equipped lugs - L = 1.20 m 1 earth cable 35 mm ² - L = 2 m	14.5	4.4

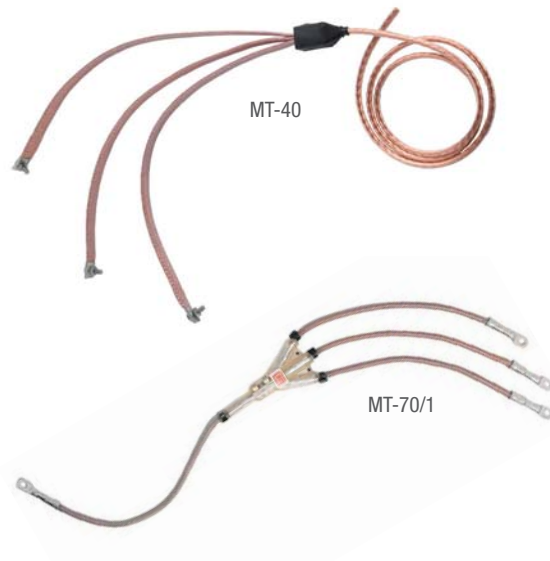

ON REQUEST CONTACT OUR TECHNICAL ASSISTANCE

We realize specific earthing and short circuiting systems with crimped cables.





Phone : (33) 01 42 31 46 24 • www.catuelec.com



CABLE TESTING STICK

Enables piercing of cable insulation and shielding, earthing up to 50 kV. Capacity: 70 mm dia.
 Cable-guide with protecting guide. 0.60 m insulating sleeve with 0.80 m extender.
 Double cutting angle blade.
 Multistrand copper earth wire 70 mm² x 2.50 m with earth clamp.
 Ratchet type operating handle.





Reference		 mm	
MP-211	1.60 m	Ø 60 maxi	8.75

Carrying Case available separately (MP-02).

INSULATING BLANKET

Must be placed over the piercing point
 Hole for handle.



Reference	 mm	 mm	
MP-212	900 X 900	Ø 50	0.96

CABLE SPIKE EQUIPMENT

Device to test the voltage on underground cables (1st and 2nd categories) and their earthing, using a system with 9^{**} mm bullet and throwing in the cable a steel treated blade.



Reference	Description	
MP-213 *	Cable spike	20
MP-213/LAM	Spare blade for spade-cable MP-213	0.02
MP-213/EXT	Blade extractor for spade-cable MP-213	0.20

* Delivered complete in suitcase.

** 9 mm bullet not included and not supplied by CATU.

 Total length

 Dimensions
mm

 Weight

 Diameter
mm





MANOEUVERING HOOK

Reference	Characteristics	kg
CM-02-(*)	Bronze-copper nickel aluminium	0.12
CM-03-K	Bronze-copper nickel aluminium	0.12

(*) Add end-fitting: C, E or K.



CM-02-K



CM-02-C



CM-03-K

CLEANING BRUSHES

Reference	Characteristics	mm	kg
MD-10-C	Concave brush with two rows of perpendicular bristle	100 x 125 x 170	0.5
MD-12-C	Round head brush	175 x 228	0.5
MD-14-C	Adjustable hinged round head brush	175 x 328	0.5



MD-12-C



MD-10-C



MD-14-C

TRIMMER AND PRUNNING SAW

Reference	Characteristics	mm	kg
MD-40-B	Trimmer, maximum capacity Ø 45 mm (for branches up to 28 mm depending on tree species)	375 x 240 x 60	1.2
MD-42-B	Pruning saw on rigid frame, 34 cm blade	125 x 610 x 60	1.1
M-92-28	Replacement blade MD-42-B	—	—



MD-40-B



MD-42-B

FUSE PULLER

All parts in metal protected against corrosion.

Reference	mm	mm
CM-04-K	230 x 80	up to 70



ROD TESTER

The portable rod tester is designed to measure leakage currents originating from the absorption of humidity or pollution on the surface of insulating rods conform to IEC 60855 standard.

The rod tester does not require any particular gauging and works according to the "Good / No good" principle and there is no need for any particular interpretation of the results. The validation of the satisfactory state of the rod takes place by means of a clear information on the galvanometer screen.

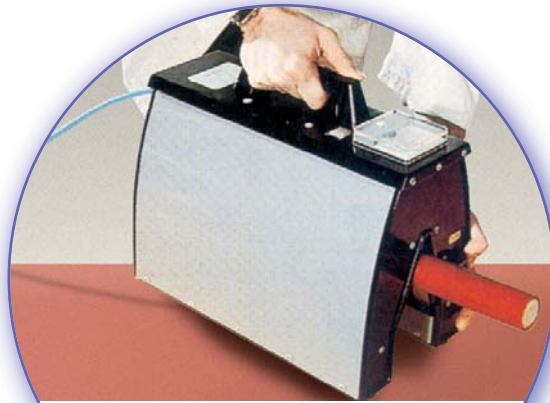

Easily transportable.

Reference	Characteristics	 mm	 kg
MX-215	Rod tester	210 x 480 x 350	10.2

THE

- 1 In accordance with ERDF BT MT 82 specification.
- 2 Quick and simple use.



Railways

Electrical safety equipment



Short-circuiting system

Warning light

Safety equipment

Head and eyes protection

Insulating rubber

CATU™

HV lines and switchgear equipment

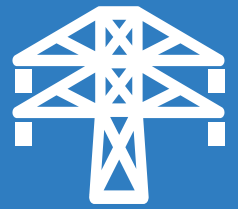

<u>Voltage detectors</u>	186
<u>Insulating sticks</u>	188
<u>HV lines and switchgear equipment</u>	189
<u>Earthing system (APE)</u>	190
<u>Insulating sticks and earth clamps</u>	191
<u>Copper and aluminium cables</u>	192
<u>Accessories</u>	193





AC VOLTAGE DETECTOR FOR OUTDOOR USE

IEC electronic voltage detector "Ultra Compact Series" for outdoor use.
 Ultimate "head capacitive technology" of voltage detector.
 Universal application 50/60Hz and wide band of voltage from 44 to 32kV.

Voltage presence is indicated by :

- RED flashing led (very bright, visible up to 20 m in direct lighting).
- powerful rated audible signal 67dB(A)/1.5 m.

Operating check :

- by pressing the Test Button, correct operation is indicated by RED LED flashing on and a sound signal.
- After releasing the Test Button, a timed green LED lights on.
- It indicates the good working order of the detector.

Contact electrodes (hook shaped) fitted to the body by screwing and easily interchangeable.

Characteristics :

- Contact electrodes fitted to the housing by screwing and are easily interchangeable.
- Visible light is also indicated on the circumference of the disk for better visibility.
- Robust housing thermoplastic

Delivered in a carrying bag.

For other voltage, please consult us.

IEC 61243-1 SUPP



THE ⊕





- 1 Visible light on 360°.



End fittings

End fitting "C": hexagonal male 12 mm on flats, for hexagonal end fitting sticks.

End fitting "K": for Universal end fitting sticks.

Reference	 (Operating voltage)	Contact electrode	Case colour	 type 6 LR 61		
CC-765-44/132	44 - 132 kV	Ø 120 mm		9 V	-25/+55 C°	350

AC VOLTAGE DETECTOR FOR OUTDOOR USE

Precise and stable operating threshold. Insensitivity to induced voltages by limiting the operating voltage range. Remarkably resistant to impacts, vibrations, extreme temperatures, humidity.

Double signaling.

Voltage presence indicated at the same time by:

- 4 bright **RED** flashing electro-luminescent diodes (visible at more than 50 meters even in direct lighting),
- a powerful rated acoustic signal (60 dB/2 m).

The **CC-265** detectors is supplied with 3 end fittings for sticks

- W** : Hexagonal 20 mm,
- C** : Hexagonal 12 mm,
- K** : Universal.

Robust housing made from polycarbonate with high mechanical properties and dielectric strength.

Check that the device is working by pressing the TEST button. This test all of the detector's active components once the TEST button is released.

Surrounded by a rubber impact-resistant padding.

Two **GREEN** illuminated lights, indicating that the device is on. These lights turn off, and four lights illuminate when a voltage is detected.

IEC 61243-1



CC-265-60/90

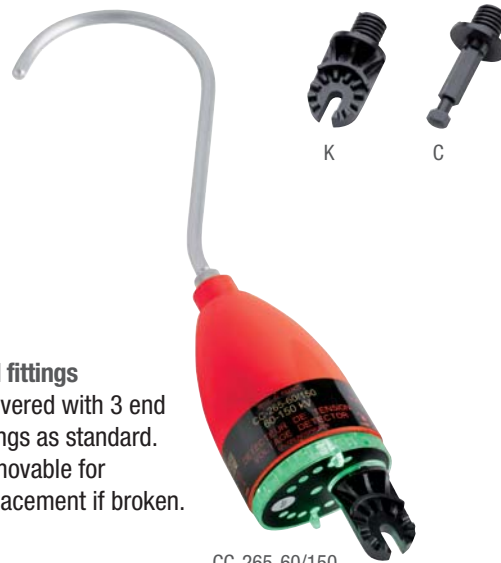

CC-265-60/150

End fittings
Delivered with 3 end fittings as standard. Removable for replacement if broken.

THE

- 1 Illuminated display Broadcast over 360°.
- 2 Use in rain.
- 3 Shock Absorber Tip.

Reference	IEC 61243-1 edition 2	(Operating voltage)	Contact electrode	Case colour	type 6 LR 61		
CC-265-44/132-(*)	•	44 - 132 kV	Ø 120 mm		9 V	-25/+55 C°	0.65
CC-265-60/90-(*)	•	60 - 90 kV	Ø 120 mm		9 V	-25/+55 C°	0.65
CC-265-60/150-(*)	•	60 - 150 kV	Ø 120 mm		9 V	-25/+55 C°	0.65
CC-260-60/235-(*)	-	60 - 235 kV	Ø 120 mm		9 V	-25/+55 C°	0.65
CC-265-90/225-(*)	•	90 - 225 kV	Ø 120 mm		9 V	-25/+55 C°	0.65
CC-265-120/245-(*)	•	120 - 245 kV	Ø 200 mm		9 V	-25/+55 C°	0.65
CC-260-132/380-(*)	-	132 - 380 kV	Ø 200 mm		9 V	-25/+55 C°	0.65
CC-260-150/420-(*)	-	150 - 420 kV	Ø 200 mm		9 V	-25/+55 C°	0.65
CC-265-225/420-(*)	•	225 - 420 kV	Ø 200 mm		9 V	-25/+55 C°	0.65
CC-260-225/550-(*)	-	225 - 550 kV	Ø 200 mm		9 V	-25/+55 C°	0.65
CC-265-315/765-(*)	Coming soon	315 - 765 kV	Ø 200 mm		9 V	-25/+55 C°	0.65

Delivered with modern, lightweight and impact-resistant case.
(* Please specify type of mounting when ordering : C or K
For other voltages, please consult us.



INSULATING STICKS FOR MANOEUVERING DETECTORS & SHORT-CIRCUITING AND EARTHING SYSTEMS

This range thus allows a stick-length limitation in case of space requirements and carrying capabilities. For common applications a serie of complete sets including 2 or 3 elements are providing simple solutions for working distance from 2 to 6 meters.

THE ⊕

1 Quick and simple use.

	Reference	↔ smallest end fitting	↔ longest end fitting	↔ mm Insulating	kg
Basic	CM-4610	1.13 m	-	0.12 m	1.25
	CM-4615	1.63 m	-	0.38 m	1.70
	CM-4620	2.13 m	-	0.38 m	2.70
	CM-4625	2.63 m	-	0.88 m	3.20
Intermediate	CM-4610-I	1.165 m	-	0.80 m	1.20
	CM-4615-I	1.665 m	-	1.30 m	1.60
	CM-4620-I	2.165 m	-	1.80 m	2.50
	CM-4625-I	2.665 m	-	2.30 m	3.00
Terminal	CM-4610-(*)	1.115 m	1.21 m	0.70 m	0.90
	CM-4615-(*)	1.615 m	1.71 m	1.20 m	1.30
	CM-4620-(*)	2.115 m	2.21 m	1.80 m	2.10
	CM-4625-(*)	2.615 m	2.71 m	2.20 m	2.60
Fixed sticks	CM-4115-(*)	1.575 m	1.675 m	0.82 m	1.35
	CM-4120-(*)	2.075 m	2.175 m	1.07 m	1.8
	CM-4125-(*)	2.575 m	2.675 m	1.32 m	2.8
	CM-4130-(*)	3.075 m	3.175 m	1.82 m	3.3

(*) Reference to be completed by fitting: C-E-H-K-T-D.

Accessories :

Reference	↔ smallest end fitting	kg
CM-3900-J	0.36 m	0.95



IEC 60855
EN 50508

Basic element. Intermediate element. Terminal element.



Intermediate element with rain skirts.

SET OF STICKS

Complete sets of sticks for common applications.

Reference	Composition	↔
CM-4220-(*)	2 elements : CM-4610+CM-4610-(*)	2 m
CM-4230-(*)	2 elements : CM-4615+CM-4615-(*)	3 m
CM-4240-(*)	2 elements : CM-4620+CM-4620-(*)	4 m
CM-4345-(*)	3 elements : CM-4615+CM-4615-I+CM-4615-(*)	4.5 m
CM-4360-(*)	3 elements : CM-4620+CM-4620-I+CM-4620-(*)	6 m

(*) Reference to be completed by fitting: C, E, H, K, T et D.

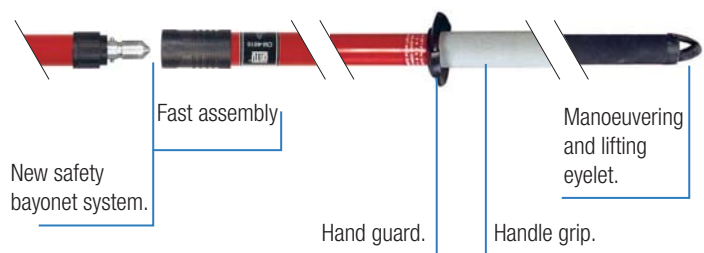

CLAMPS

Body in aluminium alloy with trapezoidal threaded screw. Interposed elastic washers in the clamping system improve efficiency and ensure a higher withstand in case of electrodynamic shock. Manoeuvring by CM-6 insulated stick of appropriate length and characteristics.

IEC 61230



MT-731-E



MT-732-E



MT-734



MT-735-H



MT-737-H

Manoeuvrable clamps

MT-732-A MT-731-A	MT-732-B MT-731-B	MT-732-E MT-731-E	MT-732-H MT-731-H	MT-734 MT-735	MT-734-A MT-735-A	MT-734-B MT-735-B	MT-734-E MT-735-E	MT-734-H MT-735-H

Reference	Rating (kA/1 s)	Dimensions (mm)	Copper connection			Clamp capacity (mm)	Weight (kg)
			Copper cables **	Contact range width	Stud		
MT-731-(*)	40	200 x 200 x 50	150 mm ² max.	45 mm	M 12	∅ 5-60	∅ 5-60
MT-732-(*)	40	200 x 200 x 50	150 mm ² max.	45 mm	M 12	∅ 40-120	∅ 40-120
MT-734-(**)	40	145 x 125 x 52	150 mm ² max.	40 mm	M 12	∅ 5-40	∅ 5-40
MT-735-(*)	40	178 x 175 x 60	150 mm ² max.	40 mm	M 12	∅ 15-60	∅ 15-60
MT-737-H	40	240 x 200 x 55	150 mm ² max.	40 mm	M 12	∅ 20-120	∅ 20-120

(*) Add type of connection A - B - E - H.

(**) Add type of connection B - E - H.

**Other cable sections: see page 191, 192.

Attachment of MT-735 or MT-734 clamps with MT-717-3-B hook.



Direct connection.

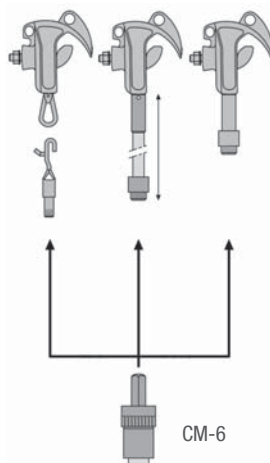

Connection adaptor.

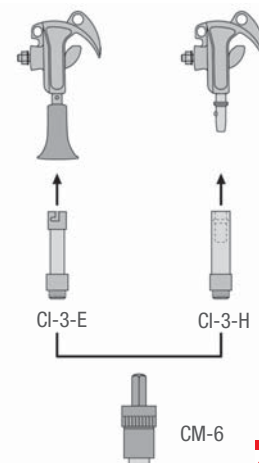

Total length
 Weight
 Diameter
 Dimensions
 Clamp capacity



EARTHING SYSTEM WITH CLAMPS INTERLOCKING

The APE is a grounding system with an interlocking system between earthing and line clamps. It is used for safe and accurate installation (earthing clamp and then line clamp) and removal (line clamp and then earth clamp).

THE

- 1 Locking system using a patented system with more than 30,000 possible combinations.
- 2 Easy installation and removal without additional accessories.
- 3 Automatic trip at the recommended torque on support withstand the short circuit current.
- 4 System security (unable to be unlocked without the associated clamp).

Substation clamp



Line clamp



ONE REFERENCE INCLUDING 3 PHASES, SO 3 CLAMPS EQUIPPED.

Reference	Rating	Use	Fitting	Connection		mm	mm	
				Range	Stud			
MT-834-H	40 kA/1 s	Substation	H hexagonal	width 38 mm	M 12	360 x 200 x 85	• 5 - 40	3.2
MT-834-E	40 kA/1 s	Substation	E bayonet	width 38 mm	M 12	360 x 200 x 85	• 5 - 40	3.2
MT-834-T	40 kA/1 s	Substation	T bayonet	width 38 mm	M 12	360 x 200 x 85	• 5 - 40	3.2
MT-835-H	40 kA/1 s	Substation	H hexagonal	width 38 mm	M 12	390 x 200 x 85	• 15 - 60	3.48
MT-835-E	40 kA/1 s	Substation	E bayonet	width 38 mm	M 12	390 x 200 x 85	• 15 - 60	3.48
MT-835-T	40 kA/1 s	Substation	T bayonet	width 38 mm	M 12	390 x 200 x 85	• 15 - 60	3.48
MT-837-H	40 kA/1 s	Substation	H hexagonal	width 38 mm	M 12	470 x 220 x 85	• 20 - 120	3.88
MT-837-E	40 kA/1 s	Substation	E bayonet	width 38 mm	M 12	470 x 220 x 85	• 20 - 120	3.88
MT-837-T	40 kA/1 s	Substation	T bayonet	width 38 mm	M 12	470 x 220 x 85	• 20 - 120	3.88
MT-934	40 kA/1 s	Line	ring	width 38 mm	M 12	360 x 200 x 85	• 5 - 40	3.2
MT-935	40 kA/1 s	Line	ring	width 38 mm	M 12	390 x 200 x 85	• 15 - 60	3.48

INSULATING STICKS FOR SHORT CIRCUITING AND EARTHING SYSTEMS

CM-6 series is recommended for cables $\geq 95 \text{ mm}^2$. Yellow colour elements, with superior characteristics, they are connected between them without any prior order of assembly.

These elements allow "long length" assemblies which can support short-circuit systems with large cross-section cables. Shockproof guard and pole end cap. Yellow colour elements.

Composite tube fiber glass and epoxy resin, yellow colour.

Reference	↔	∅ mm	kg
CM-6-15	1.5 m	47	2.4
CM-6-20	2 m	47	3.2
CM-6-25	2.5 m	47	4
CM-6-30	3 m	47	4.8



Example of assembly of clamps on the stick.



CM-6-15 CM-6-20 CM-6-25

IEC 61235



EARTH CLAMPS FOR OVERHEAD LIVE NETWORKS AND SUBSTATIONS

Copper aluminium bronze earth clamps.



MT-843



MT-843-P



MT-847



MT-852



MT-853

Reference	Rating	Use	Connection ∅ (mm)	Dimensions mm	Clamp capacity mm	kg
MT-843	40 kA/1 s	Substation/ Overhead line	Hole : ∅ 12.5	45 x 106 x 165	• ∅ 6 - 25 - 0 - 35	0.95
MT-843-P	40 kA/1 s	Substation	3 Holes : ∅ 12.5	45 x 106 x 165	• ∅ 6 - 35 - 0 - 35	0.95
MT-847	25 kA/0.5 s	Overhead line	Hole : ∅ 13	45 x 106 x 170	- 0 - 30	1.00
MT-852	63 kA/0.5 s	Substation	Hole : ∅ 13	70 x 125 x 155	Fixed points	1.40
MT-853	40 kA/0.5 s	Substation	Hole : ∅ 13	65 x 130 x 135	Fixed points	1.00

COPPER CABLES

Extra-flexible braided multi-strand copper.

Delivered to the meter with a minimum of 5 meters.

Available in vinyl or silicone sheath.



IEC 61230





EQUIPOTENTIAL LINES

USE

Conductive line connecting two pieces of metallic pieces in order to give them the same potential.

- Cable composition and features :

35 mm² copper cable insulated in a green silicone sheathing.
Double crimped lugs at the cable ends.

Reference	Characteristics
M-24-35-V	Cable 35 mm

- Clamp and stick composition and features :

Insulating stick equipped with a clamp MT-735 in aluminium alloy with Ø 15 to 60 mm clamp capacity.

Reference	Characteristics
MT-735-P4	Clamps MT-735 on stick 400 mm

- Earth Clamp composition and features :

All the earth clamps of page 191 are available to complete the equipotential lines.



IEC 61230



Aluminium cables

Extra flexible braided multi-strand cables. Transparent PVC sheath, with cable section identification.

Reference	Rating (kA/1 s)	Cable		Section (mm ²)
		Weight (kg/m)	Ø (mm)	
M-28-70	10.0	0.240	13.4	70
M-28-120	17.5	0.430	19.00	120
M-28-150	20.0	0.510	21.00	150



ADJUSTABLE ACCESS POINTS

For large vertical or oblique heavy duty conductors.



Reference	Characteristics	Icc (kA/1 s)	mm	Conductor		kg
				Type	Ø mm	
MT-790	Copper/Alu alloy Ø 18 mm	30	255 x 105 x 50	Copper	Ø 12 - 60	1.40
MT-792	Light alloy Ø 20 mm	30	270 x 105 x 60	Aluminium	Ø 12 - 60	0.85
MT-797	Light alloy Ø 20 mm	30	240 x 170 x 60	Aluminium	Ø 60 - 120	1.20

SHORT-CIRCUITING AND EARTHING SYSTEM CARRYING BAGS

Can receive earthing system equipment (clamps and cables).

Reference	mm	kg
M-87-53	380 x 250 x 400	2
M-87-153	380 x 250 x 600	2.5
M-87-295	550 x 300 x 300	1.5



M-87-295

M-87-153

ROPE OPERATED CLAMP

Attachment and removal is carried out from the ground or from the cross-arm, using a rope passed previously over the conductor to be earthed. Up to 10 m: by using **MT-709-B** reel launcher placed on a **CM-6 SERIE Stick** (see page 191) that passes the rope over the conductor;

- This projector fires an arrow carrying a braided nylon wire which sets the rope. The clamp is then fixed to the rope and attached onto the conductor.

Attachment: the clamp is pulled up by the rope. Pulling on the rope triggers the spring and closes the jaw.



Removal: pulling on the rope attached to the hinged saddles causes the clamp to pivot and free the jaw.

Spring operated swinging jaw with pre-set.



MT-709-B

MT-708-40

Reference	 mm	lcc (kA/1 s)	 mm	 kg
	Ø 12 - 48	30	195 x 120 x 175	2
MT-701/1	Earthing cable: cable 120 mm ² with crimped lugs on M12 screw (x3)			

MT-701/1



WIRE GUN TESTER

An extremely simple way to test the voltage in an overhead line without leaving the ground. Just shoot a weighted arrow over the line - up to 18 m high - forming contact between the conductors through a very lightweight braided steel cable.

If they are both live, this produces a sparkover and alerts the user.

The **MF-60** gun can also be used to shoot an insulating cord for handling **MT-701/1** contact clamps.

Reference	Characteristics
MF-60	Complete cable-launcher projector delivered in a waterproof bag with 2 spare arrow and 2 spool of 30 m fuse wire 3.5 kg
MF-61	Spare arrow
MF-62	Spool of 30 m of fuse wire
MF-63	Spool of 100 m of fuse wire
MF-66	Spool of 30 m of nylon lead isolated hoisting cord.isolantes



MF-61

MF-60





ISOLATION 1kV = ELECTRICAL SAFETY

A range of safety footwear
designed for electricians.



See page 29

MV-223-(*)



MV-222-(*)



MV-226-(*)



MV-227-(*)



MV-228-(*)



Earthing connections



Earth rods **196**

Earthing connections **197**

**Golden safety rules for short-circuiting
and earthing system** **199**





Earth rods

GENERAL

The rod is, in most cases, the most practical, effective and reliable earth connection means.

Highly effective: for a given contact surface area, the linear type electrode provides, both theoretically and practically, the least earth resistance. Furthermore, it enables the most moist and conductive layers to be reached. Easy and quick to install, it requires no earth work. Even inside industrial buildings, it is often possible to install an earth rod exactly where required by breaking through a small area of the floor.

Accessible and testable connection: the use of an inspection box makes it possible to leave the head of the rod and its connection unburied and to periodically test it and measure its resistance.

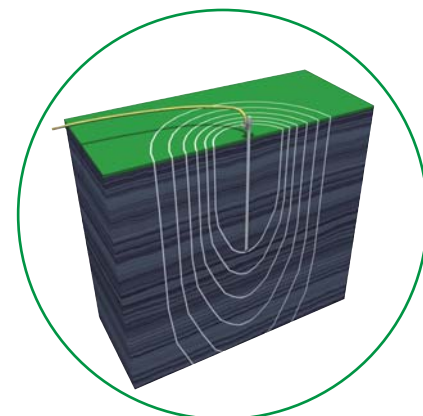

Self connectable rods: The lower end of each rod is equipped with a point used both for driving into the earth and for connection; the upper pierced end receives (without the sleeve) the point of the previous rod. Use a rivetting head so as not to damage the upper end when driving in.

Connectable rods: Conical slide-in provides perfect assembly stability. For deep earth connections.

COPPER/STEEL EARTH RODS

Steel with copper coating by electrolytic process: Minimum Thickness 250 μ (* = 350 μ).

Reference	Type	\varnothing mm	\longleftrightarrow	kg	Connection
CC-10-Y	standard with connector	14.2 unit 16	1 m	1.2	BCY
CC-15-Y			1.50 m	1.8	
CC-20-Y			2 m	2.4	
C2C-10-Z ⁽¹⁾	Connectable	17.3 unit 19	1 m	2	C2C-95Z
C2C-15-Z ⁽¹⁾			1.50 m	2.8	

Self connectable Copper/Steel earth rods

Reference	Type	\varnothing mm	\longleftrightarrow	kg	Connection
A3MC-10-Z*	Self connectable	17.3 unit 19	1 m	1.8	TO-3-16/19 TO-2-19 C2C-95-Z
A3MC-15-Z*			1.50 m	2.75	
AC-10-Y	Connectable ⁽¹⁾	14.2 unit 16	1 m	1.25	TO-3-16/19 TO-2-16 BCY MCY PCY
AC-15-Y			1.50 m	1.9	
A2C-10-Z*	Connectable ⁽¹⁾	17.3 unit 19	1 m	1.95	TO-3-16/19 TO-2-19 C2C-95-Z C2C-95-Z C2C-95-Z
A2C-15-Z*			1.50 m	1.85	

(1) For connectable models, sleeves and tips are ordered separately.

STAINLESS STEEL EARTH RODS

Strength steel ≥ 90 daN/mm².

Reference	Type	\varnothing mm	\longleftrightarrow	kg	Connection
AMI-10	Connectable	16	1 m	1.45	B.CHROM
AMI-15			1.50 m	2.2	

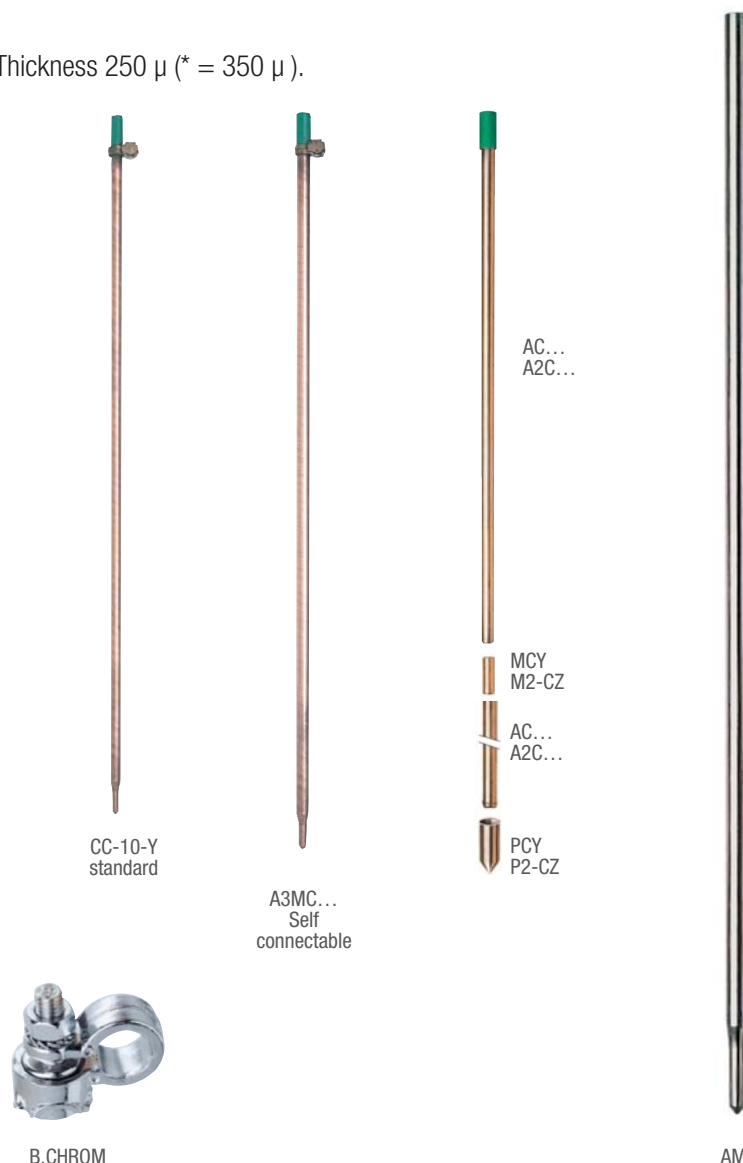

CONNECTORS

Reference	Ø Rod mm	Conductors section max (mm ²)	Type section max (mm ²)
TO-2-16	16	40	Copper
TO-2-19	19	40	Copper
vTO-3-16/19	19	6 to 95	Copper-aluminium alloy
BCY	14.3	95	Copper-aluminium alloy
C2C95Z	17.3	95	Copper-aluminium alloy

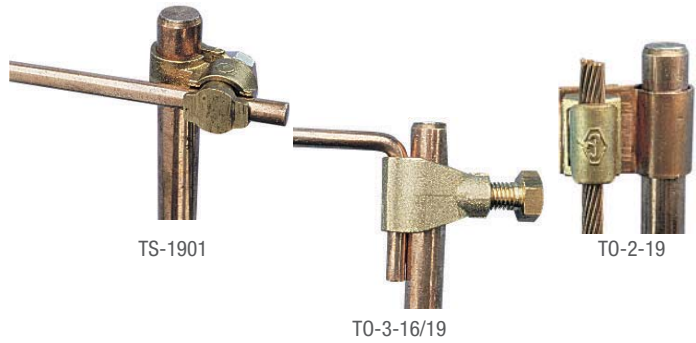

EARTHING CONNECTORS

Interconnects to earth every metallic part of installations.

Reference	Conductors section (mm ²)	mm
COL-8/32	1 x 2.5 to 2 x 6	8 to 32
COL-32/100	1 x 2.5 to 2 x 16	32 to 100



LIVE WORKING TOOLS



Since the second world war, CATU has worked in close co-operation with EDF and RTE to research and develop safety equipment and practices for use on low and high voltage networks, initially in France and now worldwide.

Utilities would be better off efficiency of their networks by avoiding outages, whatever the costs. With the increasing recognition of EDF-Serect worldwide, CATU is fast becoming a major supplier in live line working equipment. All the tools meet the specifications of the International Electrotechnical Committee (IEC).

CATU tools have a liveline life of around 20 years.

Catalogue available upon request.





EARTH RESISTANCE TESTER

The **MX-430-M** allows the measurement of earth resistance and earth specific resistivity and also the parasite voltages caused by grounding parasitic voltage presence.

This equipment is suitable for fast and easy measurement of the grounding resistance in home, industrial buildings, substations,...

Technical features

- **Application:** measurement of grounding resistances (with 3 earth rods), earth resistivity (with 4 earth rods) and parasite voltage presence.
- **Range of measurement:** 0 - 20 Ω ; 0-200 Ω ; 0-2000 Ω and 20 KΩ.
- **Voltmeter:** voltmeter function in AC range as a conventional voltmeter 0-200 V AC.
- **Operation frequency:** 1470 Hz.
- **Current in and out put power:** less than 0,5 W and the output current is limited to less than 15 mA (peak to peak).
- **Operation temperature:** -10°C / +50°C.
- **Storage temperature:** -25°C / +65°C.
- **Humidity:** 95% RH (without condemnation).



Reference	↔	kg
MX-430-M	221 x 189 x 99	2

THE ⊕

- 1 High visibility 3 1/2 digit display with direct readings, even under sunlight.
- 2 Connexion wire including a 12 V car battery.
- 3 Rechargeable internal battery managed by a microprocessor which modulates the load current as per the status of the battery, thus increasing battery life and the service life of the device.

ACCESSORIES (MEASUREMENT KIT)

MX-433-T

- 1 storage bag.
- 4 earth rod copper plated steel.
- 1 x 5 meter black cable.
- 1 x 40 meter red cable.
- 2 x 20 meter cable (1 blue and 1 green).
- 1 x 5 meter green cable to connect to the grounding system.
- 1 hammer.
- 1 reel tape measure 50 m.

Reference	Conductors section (mm ²)	kg
MX-433-T	570 x 220 x 160	7.7



Golden safety rules for short-circuiting and earthing system

SEPARATE THE WORK AREA FROM ALL POSSIBLE SOURCES OF POWER-SUPPLY by opening circuit-breakers, switches...

1



2

LOCK THE LINK IN THE OPEN POSITION with a safety lock system (safety padlock)

CHECK THE ABSENCE OF VOLTAGE at source and on site, on each conductor and apparatus involved.

3



4

APPLY APPROPRIATE SHORT-CIRCUIT AND EARTHING SYSTEMS in sufficient numbers on the conductors of your network where operation is taking place.

SHOWN, WARN OTHERS AND LIMIT THE WORK AREA even during the most simple temporary maintenance operation

5





Choose your gloves size!



1 Stretch out your hand.

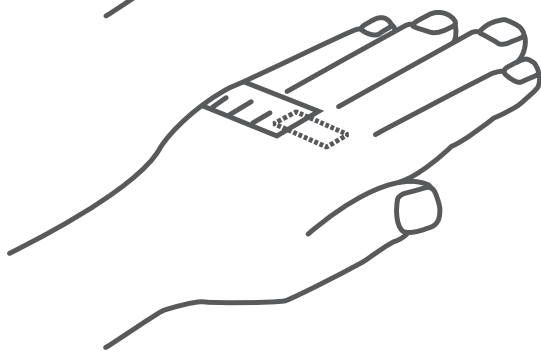

2 Wind the tape measure around your hand at the level of your knuckles. You can position the tape easier by taping it on the top of your hand.

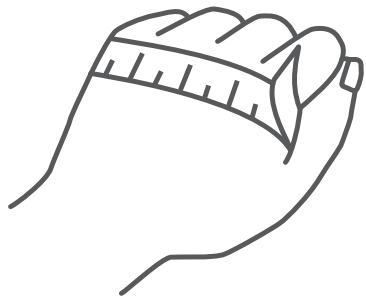

3 Slightly fold your hand without clenching your fist and take the measurement. If you are between two sizes, take the biggest one.

Women gloves size

Inch	6	6 ^{1/2}	7	7 ^{1/2}	8
cm	15.2	16.5	17.8	19	20.3
Sport size	XS	S	M	L	XL

Man gloves size

Inch	7 ^{1/2}	8	8 ^{1/2}	9	9 ^{1/2}	10
cm	19	20.3	21.6	22.9	24.1	25.4
Sport size	XS	S	M	L	XL	XL

Print this page and cut out the ruler. Ensure that the tape measures ten inches or 27.90 cm once printed (scale of your printer = 100%).

IMPORTANT
In the window of the printer's settings, check that the "scaling" drop-down menu is set to: "none".

Choose

your harness size!

Harness size board (in mm)

Reference	Chest (A)	Size (B)	Thigh (C)	Height (D)
S	700 - 1000	750 - 1000	500 - 700	600 - 750
M	800 - 1200	900 - 1200	550 - 750	750 - 850
XL	1000 - 1500	1000 - 1350	550 - 900	700 - 950

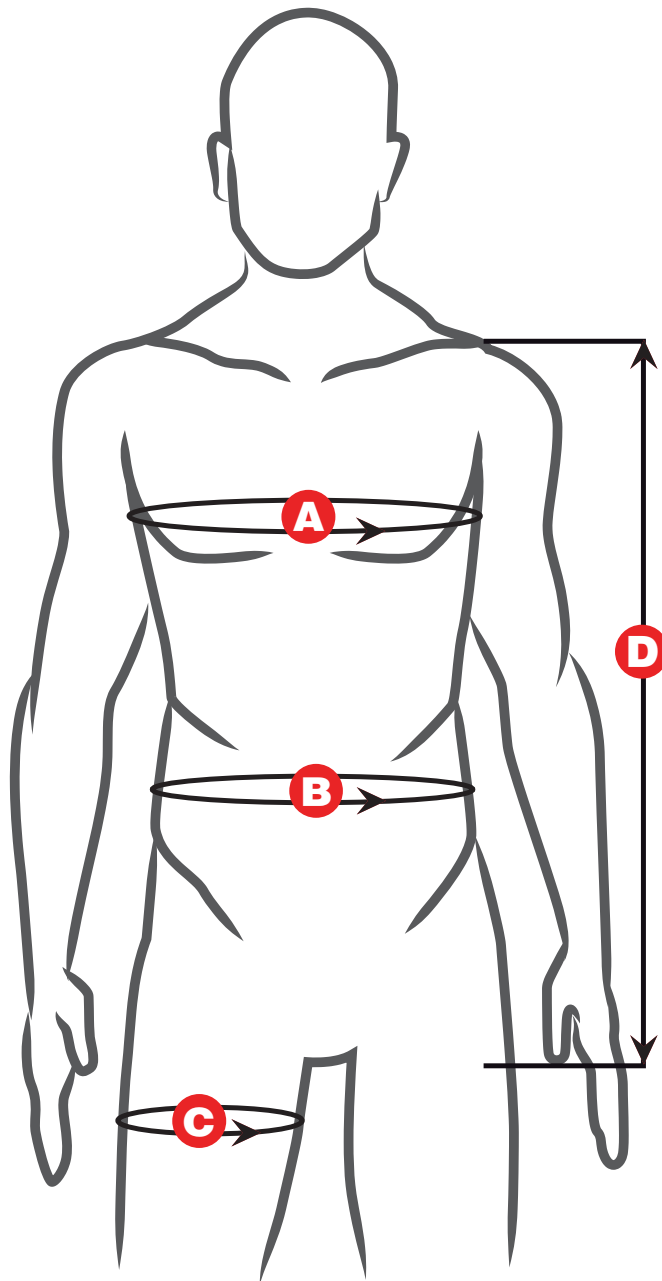

Note

A series of horizontal dotted lines for writing notes.

Specification

for short-circuiting and earthing system

A Network, electrical installation characteristics

Network voltage: _____ kV Max. short-circuiting current (1s): _____ kA
 Nature of the conductive materials: Basis Al Basis Cu

Overhead lines Switchboard or substation

- Dia. or section of the conductors: min. _____ max. _____
- Round bars dia. (mm): mini. _____ max. _____
 Length = _____
 Thickness = _____
- Flat bars
 $\left\{ \begin{array}{l} \text{H type} \\ \text{V type} \end{array} \right.$
 H type V type
 Length = _____
 Thickness = _____
- Fitting on edge face Fitting on side face

B Characteristics of the earthing system

- Selected sketch (out of the three standard types shown below)
- Distance between live conductors (m): _____, between live conductors and grounding point (m) _____
- To place the clamps in position, the operator will stand: above the conductors under the conductors
 at the conductors level
- For cable sections, please indicate max. ΔT or min. dia. of the conductor _____

C Earthing connection point

- Earth rods: dia. or thickness on side face (mm): _____ Flat bar, angle-bar, thickness (mm): _____
- Round conductor dia. (mm): _____

D Operating stick

- Insulating stick: total length _____ Fixed Connectable stick Telescopic

Characteristics

- Selected connection type: Sketch n° _____
- Contact clamps (type MT- _____)
- Short-circuiting cable
 - Length (m) _____
 - Dia. or section (mm, mm²) _____
- Grounding cable
 - Length (m) _____
 - Dia. or section (mm, mm²) _____
- Connection of cables on clamps, earth clamps, trifurcation
 - Direct connection by screw and nut
 - Connection by means of crimped lugs
- Earth clamp, type _____
- Presence of a reel _____
- Insulating stick, type _____

Sketch N°1



Sketch N°2

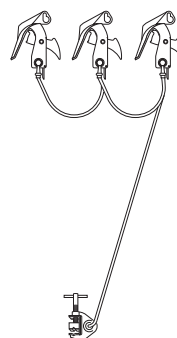

Sketch N°3

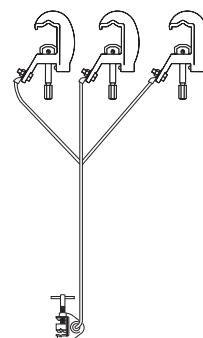

Accessories

- Carrying bag for sticks
- Canvas bag for equipment
- Carrying case for equipment
- Cable reel

The characteristics and technical informations stated in our literature are only for your guidance and therefore cannot be considered as contractual.

Our company is entitled to modify at any time the characteristics of its equipment.

In case of modification of these characteristics, our company would not be obliged to supply materials conform to those previously in force.

“Alu-Metal, Alu-Script, Catex, Catohm, Catu, Catumètre, Clipblock, Detex, Detex-Lumifix, Identex, Isomil, Isostop, Normafix, Pointest, Piezo-Test, Pelican 2, Triplix” are trade marks of Catu S.A.



© 2017 CATU S.A. BAGNEUX
All reproduction, adaptation and translation rights reserved for all countries.

Design / direction / layout: COMST - www.comst.fr

GENERAL CATALOGUE RG-13



10/20 Avenue JEAN-JAURÈS - B.P.2 - 92222 BAGNEUX CEDEX (FRANCE)
Phone: (33) 01 42 31 46 00 - Fax: (33) 01 42 31 46 32
Phone business: (33) 01 42 31 46 46

www.catuelec.com



Distributed by:

